

Service  
Service  
Service



# Service Manual



## TABLE OF CONTENTS

	Chapter
Location of PCB Boards .....	1-2
Versions Variation .....	1-2
Specifications .....	1-3
Measurement Setup .....	1-4
Service Aids .....	1-5
ESD & Safety Instruction .....	1-6
Lead-free soldering Information .....	1-7
Setting procedure & Repair Instructions.....	2
Disassembly Instructions & Service positions .....	3
Block & Wiring Diagram .....	4
DISP+LED+VOL Board.....	5
MAIN+Y.U.V Board.....	6
Power Board .....	7
MP3 IN Board .....	8
Mechanical Exploded View & Part List.....	9
Revision List .....	10

**CLASS 1  
LASER PRODUCT**

© Copyright 2009 Philips Consumer Electronics B.V. Eindhoven, The Netherlands  
All rights reserved. No part of this publication may be reproduced, stored in a retrieval system or transmitted, in any form or by any means, electronic, mechanical, photocopying, or otherwise without the prior permission of Philips.

Published by ET-SL0906 Service Audio Printed in The Netherlands Subject to modification

GB 3141 785 33350

Version 1.0



**PHILIPS**

# LOCATION OF PCB BOARDS

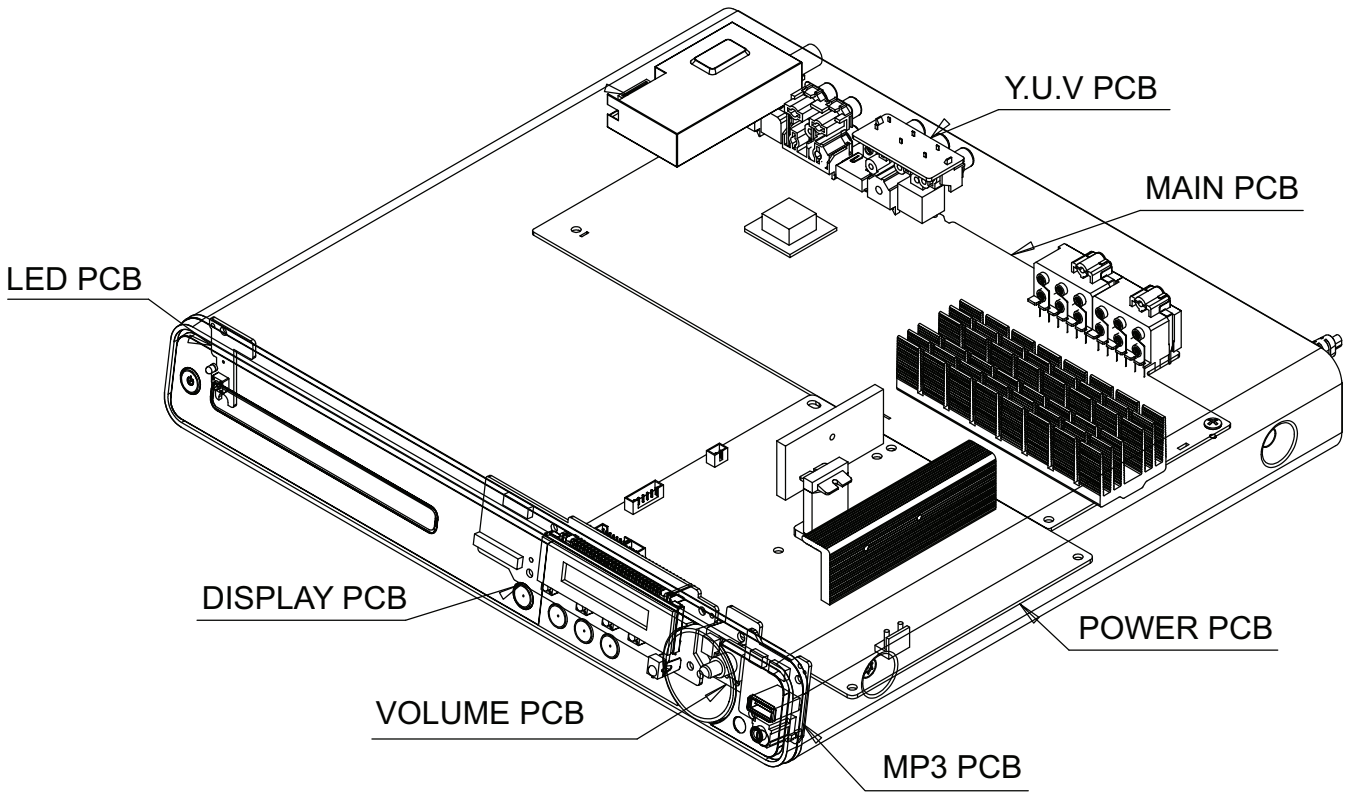

## VERSION VARIATION:

Type/Versions	HTS3371D
<b>Features</b>	<b>/F7</b>
Output Power - 1000W	X
Voltage (120V)	X
MP3 Link	X

## SERVICE SCENARIO MATRIX:

Type/Versions	HTS3371D
<b>Board in used</b>	<b>/F7</b>
MAIN+Y.U.V Board	C
Power Board	C
DISP+LED+VOL Board	C
MP3 IN Board	C

\*C = Component Level Repair

# SPECIFICATIONS

## Playback media

DVD-Video, DVD+R/+RW, DVD-R/-RW, DVD+R DL, CD-R/CD-RW, Audio CD, Video CD/SVCD, Picture CD, MP3-CD, WMA-CD, DivX-CD, USB flash drive

## Amplifier

Total output power.....  
 Home Theater mode..... 1000 W(6 X 167)  
 FTC mode (1%THD)..... 520 W  
 ..... \* (Main Ch @ 1kHz Sub Ch 60Hzwithin 1% THD)  
 Frequency response..... 40 Hz ~ 20 kHz  
 Signal-to-noise ratio..... > 60 dB  
 ..... (A-weighted)  
 Input sensitivity.....  
 AUX1..... 400 mV  
 AUX2..... 400 mV  
 MP3 LINK..... 250 mV

## Disc

Laser Type..... Semiconductor  
 Disc diameter..... 12cm / 8cm  
 Video decoding..... MPEG1/ MPEG2 / DivX  
 ..... / DivX Ultra  
 Video DAC..... 12 bits, 108 MHz  
 Signal system..... Multi / NTSC  
 Video S/N..... 56 dB  
 Audio DAC..... 24 bits / 96 kHz  
 Frequency response.....  
 ..... 4 Hz - 20 kHz (44.1 kHz)  
 ..... 4 Hz - 22 kHz (48 kHz)  
 ..... 4 Hz - 44 kHz (96 kHz)  
 PCM..... IEC 60958  
 Dolby Digital..... IEC 60958, IEC 61937

## Radio

Tuning range..... FM 87.5-108 MHz(100 kHz)  
 26 dB quieting sensitivity..... FM 22 dBf  
 IF rejection ratio..... FM 60 dB  
 Signal-to-noise ratio..... FM 50 dB  
 Harmonic distortion..... FM 3%  
 Frequency response..... FM 180 Hz~10 kHz  
 ..... / ±6dB  
 Stereo separation..... FM 26 dB (1 kHz)  
 Stereo Threshold..... FM 29 dB

## USB

Compatibility..... Hi-Speed USB (2.0)  
 Class support..... UMS (USB Mass Storage Class)  
 File system..... FAT12, FAT16, FAT32

## Docking Station

Dimension (H X D).....34.5 X 104 (mm)  
 Weight..... 164 g

## Main Unit

Power supply..... 120V; ~ 60Hz  
 Power consumption..... 180 W  
 Standby power consumption..... < 1 W  
 Dimensions (WxHxD).....  
 ..... 360 x 57 x 333 (mm)  
 Weight..... 3.01 kg

## Speakers

System..... full range satellite  
 Speaker impedance..... 4 ohm (center),  
 ..... 4 ohm (Front/Rear)  
 Speaker drivers .....  
 Center..... 3" woofer  
 Front/Rear ..... 3" full range  
 Frequency response..... 150 Hz ~ 20 kHz  
 Dimensions (WxHxD)..... 100 x 100 x 75(mm)  
 Weight .....  
 Front..... 0.48 kg  
 Rear..... 0.45 kg  
 Center..... 0.67 kg

## Subwoofer

Impedance..... 4 ohm  
 Speaker drivers ..... 165 mm (6.5") woofer  
 Frequency response..... 40 Hz ~ 150 Hz  
 Dimensions (WxHxD)..... 163 x 363 x 369(mm)  
 Weight ..... 4.7 kg

## Laser specification

Type..... Semiconductor laser GaAlAs (CD)  
 Wave length..... 645 - 665 nm (DVD),  
 ..... 770 - 800 nm (CD)  
 Output power..... 6 mW (DVD),  
 ..... 7 mW (VCD/CD)  
 Beam divergence..... 60 degrees.

## Declaration of conformity

Model number..... HTS3371D/F7, HTS3372D/F7  
 Trade Name..... Philips  
 Responsible Party .....  
 Philips Consumer Lifestyle A Division of Philips Electronics  
 North America Corp.  
 P. O. Box 671539  
 Marietta, GA 30006-0026

Specifications subject to change without prior notice.

# MEASUREMENT SETUP

## Tuner FM

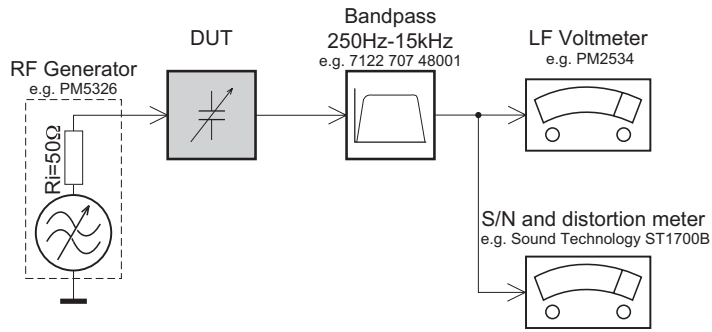

Use a bandpass filter to eliminate hum (50Hz, 100Hz) and disturbance from the pilotone (19kHz, 38kHz).

## CD

Use Audio Signal Disc SBC429 4822 397 30184  
(replaces test disc 3)

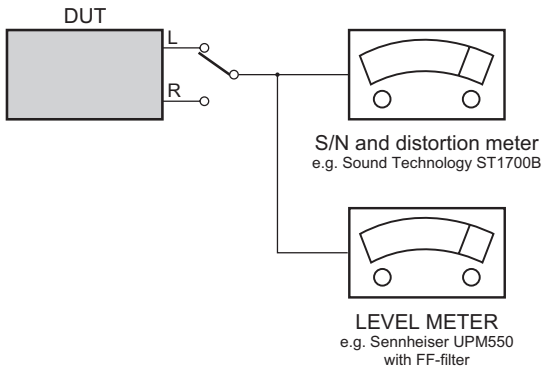



# SERVICE AIDS

## Service Tools:

Universal Torx driver holder .....	4822 395 91019
Torx bit T10 150mm .....	4822 395 50456
Torx driver set T6-T20 .....	4822 395 50145
Torx driver T10 extended .....	4822 395 50423

## Compact Disc:

SBC426/426A Test disc 5 + 5A .....	4822 397 30096
SBC442 Audio Burn-in test disc 1kHz .....	4822 397 30155
SBC429 Audio Signals disc .....	4822 397 30184
Dolby Pro-logic Test Disc .....	4822 395 10216

## HANDLING CHIP COMPONENTS

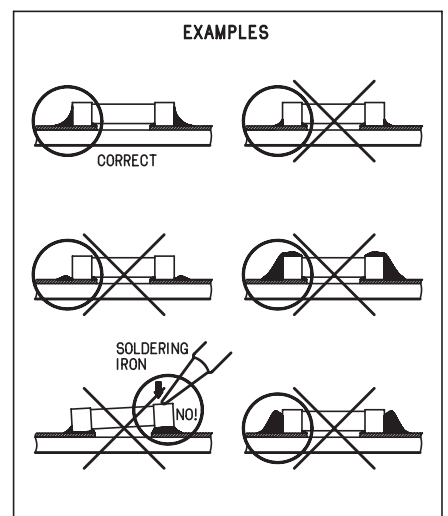
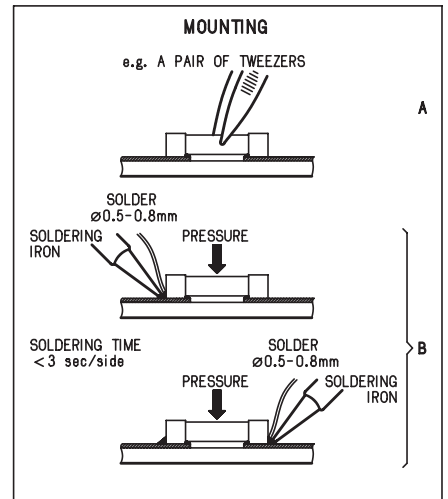
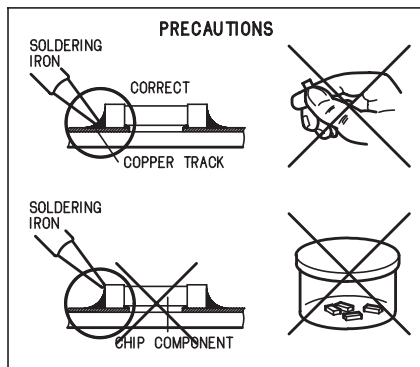
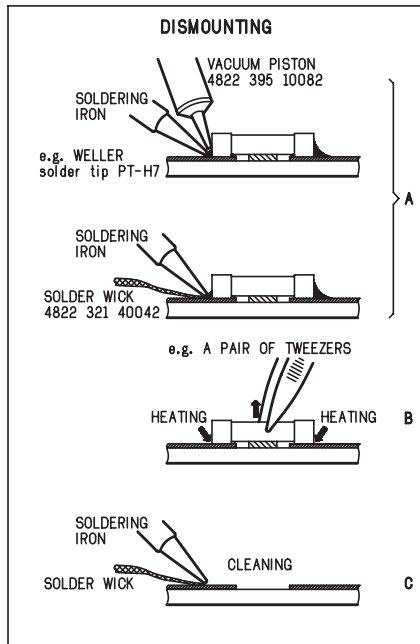
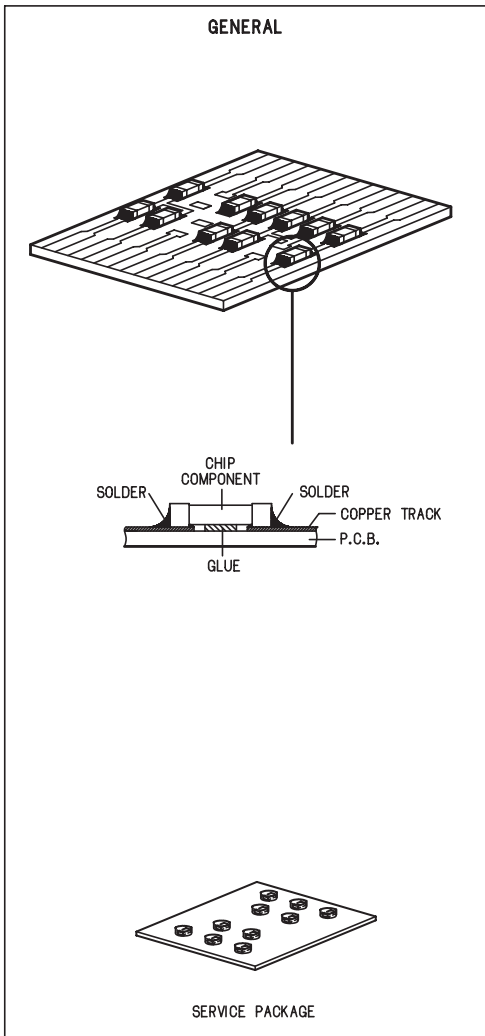

**(GB) WARNING**

All ICs and many other semi-conductors are susceptible to electrostatic discharges (ESD). Careless handling during repair can reduce life drastically.

When repairing, make sure that you are connected with the same potential as the mass of the set via a wrist wrap with resistance. Keep components and tools also at this potential.

**(F) ATTENTION**

Tous les IC et beaucoup d'autres semi-conducteurs sont sensibles aux décharges statiques (ESD).

Leur longévité pourrait être considérablement écourtée par le fait qu'aucune précaution n'est prise à leur manipulation.

Lors de réparations, s'assurer de bien être relié au même potentiel que la masse de l'appareil et enfiler le bracelet serti d'une résistance de sécurité.

Veiller à ce que les composants ainsi que les outils que l'on utilise soient également à ce potentiel.

**(D) WARNUNG**

Alle ICs und viele andere Halbleiter sind empfindlich gegenüber elektrostatischen Entladungen (ESD).

Unsorgfältige Behandlung im Reparaturfall kann die Lebensdauer drastisch reduzieren. Veranlassen Sie, dass Sie im Reparaturfall über ein Pulsarmband mit Widerstand verbunden sind mit dem gleichen Potential wie die Masse des Gerätes.

Bauteile und Hilfsmittel auch auf dieses gleiche Potential halten.

**(NL) WAARSCHUWING**

Alle IC's en vele andere halfgeleiders zijn gevoelig voor electrostatische ontladingen (ESD).

Onzorgvuldig behandelen tijdens reparatie kan de levensduur drastisch doen verminderen. Zorg ervoor dat u tijdens reparatie via een polsband met weerstand verbonden bent met hetzelfde potentiaal als de massa van het apparaat.

Houd componenten en hulpmiddelen ook op hetzelfde potentiaal.

**(I) AVVERTIMENTO**

Tutti IC e parecchi semi-conduttori sono sensibili alle scariche statiche (ESD).

La loro longevità potrebbe essere fortemente ridatta in caso di non osservazione della più grande cauzione alla loro manipolazione.

Durante le riparazioni occorre quindi essere collegato allo stesso potenziale che quello della massa dell'apparecchio tramite un braccialetto a resistenza.

Assicurarsi che i componenti e anche gli utensili con quali si lavora siano anche a questo potenziale.

**(GB) ESD PROTECTION EQUIPMENT**

Complete Kit ESD3 (small tablemat, wristband, connection box, estention cable and earth cable ..... 4822 310 10671  
Wristband tester ..... 4822 344 13999

**(GB)**

Safety regulations require that the set be restored to its original condition and that parts which are identical with those specified, be used.

Safety components are marked by the symbol  $\Delta$ .

**(NL)**

Veiligheidsbepalingen vereisen, dat het apparaat bij reparatie in zijn oorspronkelijke toestand wordt teruggebracht en dat onderdelen, identiek aan de gespecificeerde, worden toegepast.

De Veiligheidsonderdelen zijn aangeduid met het symbol  $\Delta$ .

**(F)**

Les normes de sécurité exigent que l'appareil soit remis à l'état d'origine et que soient utilisés les pièces de rechange identiques à celles spécifiées.

Less composants de sécurité sont marqués  $\Delta$ .

**(D)**

Bei jeder Reparatur sind die geltenden Sicherheitsvorschriften zu beachten. Der Originalzustand des Geräts darf nicht verändert werden; für Reparaturen sind Original-Ersatzteile zu verwenden.

Sicherheitsbauteile sind durch das Symbol  $\Delta$  markiert.

**(I)**

Le norme di sicurezza esigono che l'apparecchio venga rimesso nelle condizioni originali e che siano utilizzati i pezzi di ricambio identici a quelli specificati.

Componenty di sicurezza sono marcati con  $\Delta$ .

**(GB)**

After servicing and before returning set to customer perform a leakage current measurement test from all exposed metal parts to earth ground to assure no shock hazard exist, The leakage current must not exceed 0.5mA.

**(GB) Warning !**

Invisible laser radiation when open.  
Avoid direct exposure to beam.

**(S) Varning !**

Osynlig laserstrålning när apparaten är öppnad och spärren är urkopplad. Betrakta ej strålen.

**(SF) Varoitus !**

Avatussa laitteessa ja suojaelukituksen ohitettaessa olet alttiina näkymättömälle laserisäteilylle. Älä katso säteeseen!

**(DK) Advarsel !**

Usynlig laserstrålning ved åbning når sikkerhedsafbrydere er ude af funktion. Undgå udsættelse for stråling.

**(F)**

"Pour votre sécurité, ces documents doivent être utilisés par des spécialistes agréés, seuls habilités à réparer votre appareil en panne".

## Pb(Lead) Free Solder

When soldering, be sure to use the pb free solder.

### INDENTIFICATION:

Regardless of special logo (not always indicated)



one must treat all sets from **1 Jan 2005** onwards, according next rules:

**Important note:** In fact also products of year 2004 must be treated in this way as long as you avoid mixing solder-alloys (lead-free/ lead-free). So best to always use SAC305 and the higher temperatures belong to this.

Due to lead-free technology some rules have to be respected by the workshop during a repair:

- Use only lead-free solder alloy Philips SAC305 with order code 0622 149 00106. If lead-free solder-paste is required, please contact the manufacturer of your solder-equipment. In general use of solder-paste within workshops should be avoided because paste is not easy to store and to handle.
- Use only adequate solder tools applicable for lead-free solder alloy. The solder tool must be able
  - To reach at least a solder-temperature of 400°C,
  - To stabilize the adjusted temperature at the solder-tip
  - To exchange solder-tips for different applications.
- Adjust your solder tool so that a temperature around 360°C – 380°C is reached and stabilized at the solder joint. Heating-time of the solder-joint should not exceed ~ 4 sec. Avoid temperatures above 400°C otherwise wear-out of tips will rise drastically and flux-fluid will be destroyed. To avoid wear-out of tips switch off unused equipment, or reduce heat.
- Mix of lead-free solder alloy / parts with leaded solder alloy / parts is possible but PHILIPS recommends strongly to avoid mixed solder alloy types (leaded and lead-free).  
If one cannot avoid or does not know whether product is lead-free, clean carefully the solder-joint from old solder alloy and re-solder with new solder alloy (SAC305).
- Use only original spare-parts listed in the Service-Manuals. Not listed standard-material (commodities) has to be purchased at external companies.
- Special information for BGA-ICs:
  - Always use the 12nc-recognizable soldering temperature profile of the specific BGA (for de-soldering always use the lead-free temperature profile, in case of doubt)
  - Lead free BGA-ICs will be delivered in so-called 'dry-packaging' (sealed pack including a silica gel pack) to protect the IC against moisture. After opening,

dependent of MSL-level seen on indicator-label in the bag, the BGA-IC possibly still has to be baked dry. (MSL=Moisture Sensitivity Level). This will be communicated via AYS-website.

Do not re-use BGAs at all.

- For sets produced before 1.1.2005 (except products of 2004), containing leaded solder-alloy and components, all needed spare-parts will be available till the end of the service-period. For repair of such sets nothing changes.
- On our website [www.atyourservice.ce.Philips.com](http://www.atyourservice.ce.Philips.com) you find more information to:
  - BGA-de-/soldering (+ baking instructions)
  - Heating-profiles of BGAs and other ICs used in Philips-sets

You will find this and more technical information within the "magazine", chapter "workshop news".

For additional questions please contact your local repair-helpdesk.

## **System , Region Code , etc. Setting Prochure**

### **1)System Reset**

- Press "SETUP" button on R/C,TV will show setup menu
- Select the menu using the ▼ and ► on R/C
- Go preference page to do system reset

### **2)Region Code Change**

- In open mode, press "9" "9" "9" on R/C,then input desired number to change region code :

- |   |                       |
|---|-----------------------|
| 1 | USA                   |
| 2 | EU                    |
| 3 | AP                    |
| 4 | Australia ,NZ , Latam |
| 5 | Russia , INDIA        |
| 6 | CHINA                 |

### **3)Version Control Change**

- In open mode, press "1" "5" "9" on R/C
- Press "ok" button to confirm
- TV will show message as below:

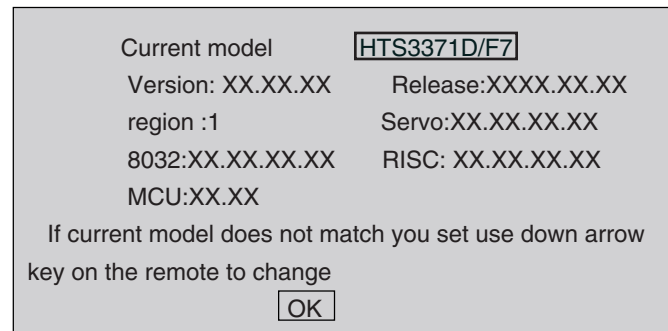

### **4)Password Change**

- Press "SETUP" button on R/C,TV will show setup menu
  - Select the menu using the ▼ and ► on R/C
  - Go preference page select "password" to change
- \* 000000 is default password supplied.

### **5)Check on the Software Version**

- Open the CD Door
- Press "INFO" button on R/C
- TV will show the version on screen

### **6)Trade model**

- Press "Open/Close " button on R/C
- Press "2" "5" "9" on R/C,VFD will display "TRA ON " or "TRA OFF"

### **7) Upgrading new software**

- Copy "software files" into a CD-R
- Open the CD Door,then insert the CD-R program disc
- Close the CD Door
- VFD will show:

"Loading"  
 "Erase" -- erase the flash memory  
 "Writing" about 1 minute  
 "done "

\* the system will switch off and on again automatically.

- OSD will show:

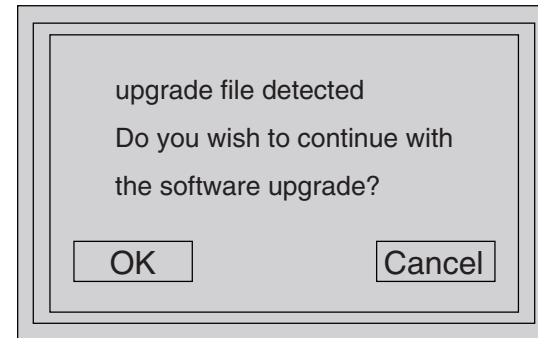

- Select "OK", OSD will show:

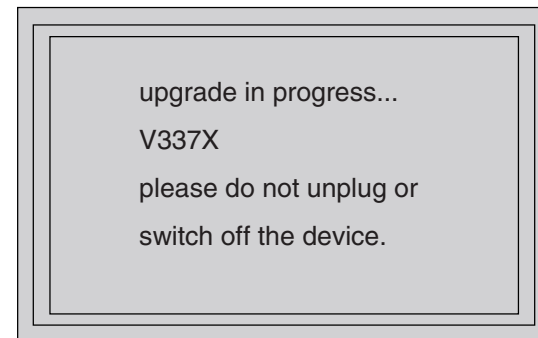

### **CAUTION!**

This information is confidential and may not be distributed.Only a qualified service person should reprogram the Region Code.

# MAIN UNIT REPAIR CHART 1/3

- A**  
 All Function  
 No Working
- B**  
 Power Supply  
 No Working
- C**  
 All Function  
 No Sound
- D**  
 Ipod input  
 No Sound
- E**  
 Audio line IN  
 No Output
- G**  
 DVD Audio  
 No Sound
- H**  
 MP3 In  
 No Sound
- I**  
 COAXIAL In  
 No Sound
- j**  
 Optical In  
 No Sound
- L**  
 Tuner No Sound
- M**  
 HDMI No Output
- N**  
 No CVBS Output
- O**  
 No Y Pr Pb output

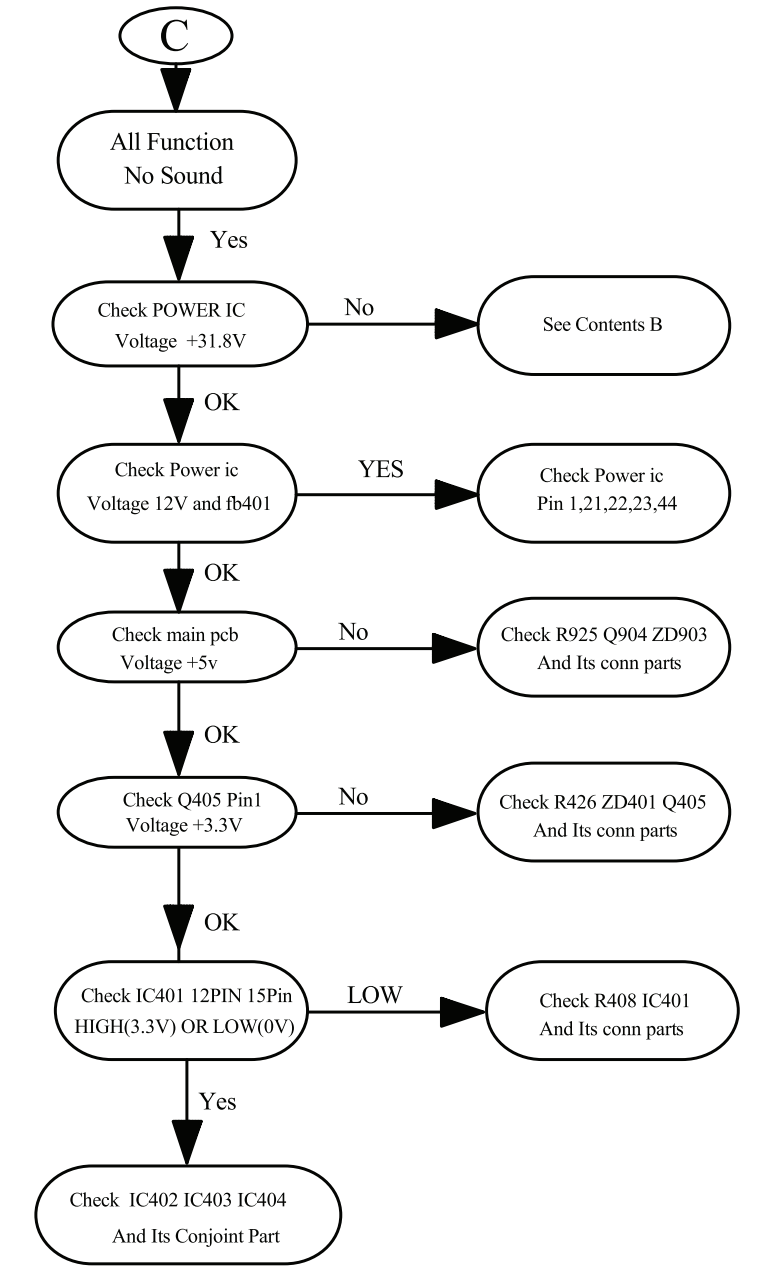
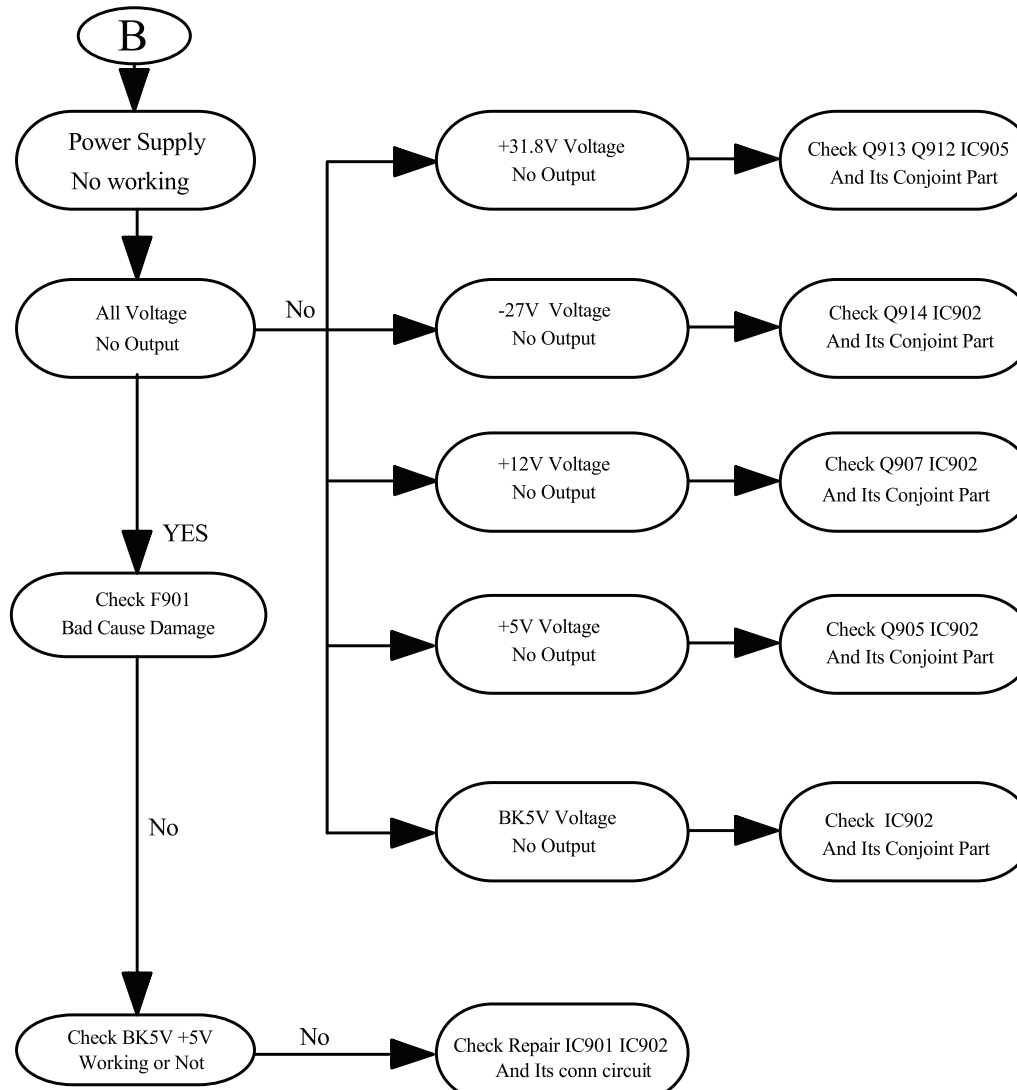
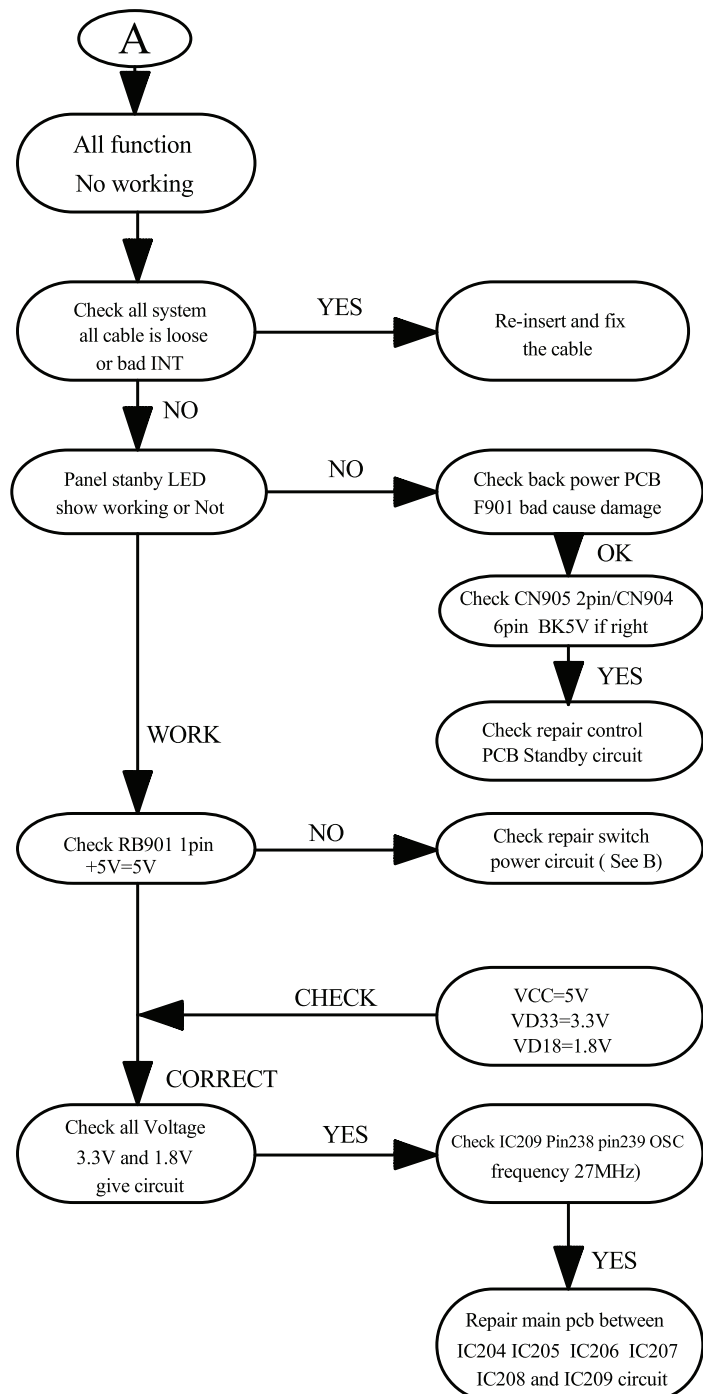

# MAIN UNIT REPAIR CHART 2/3

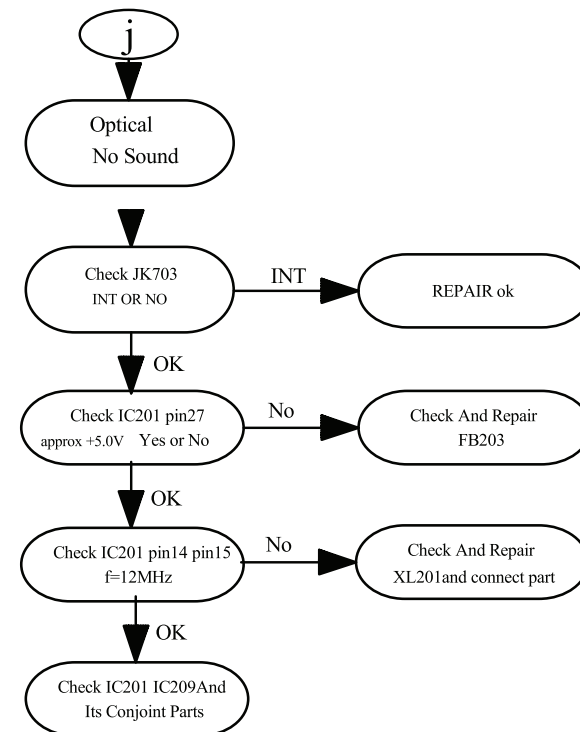
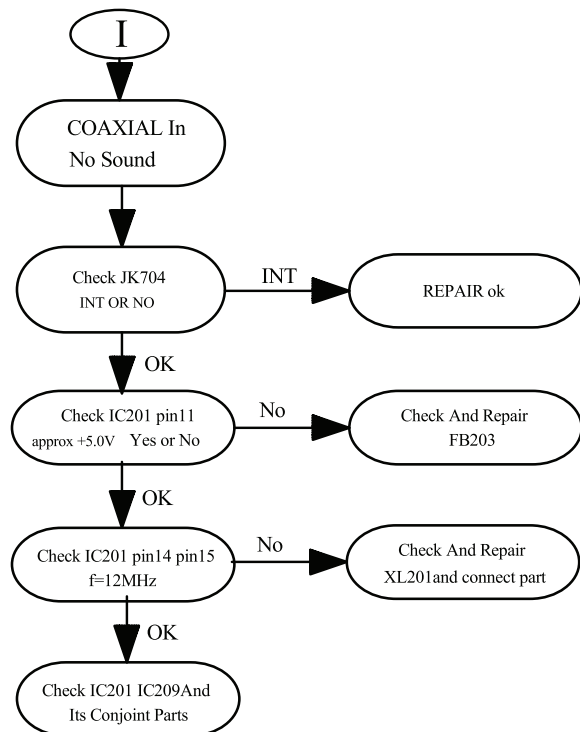
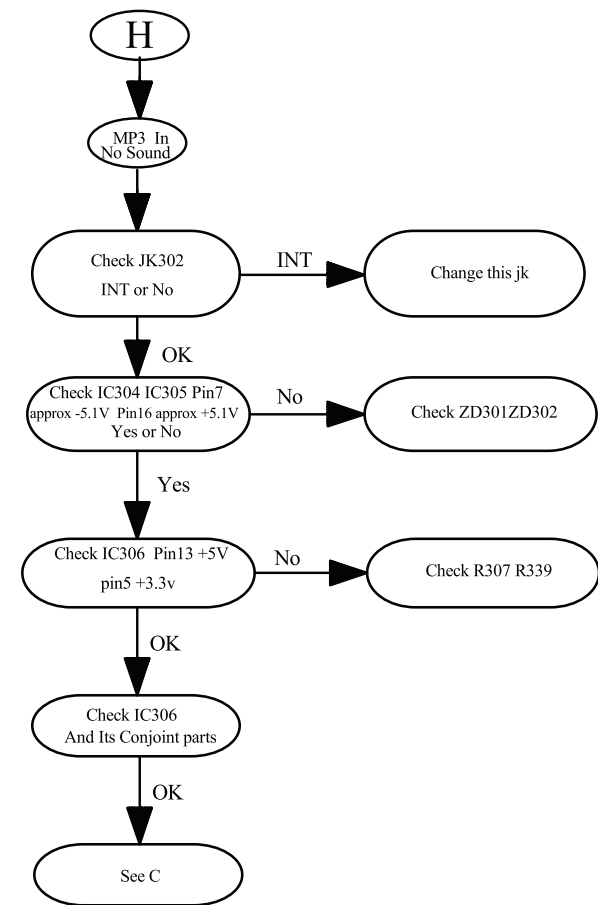
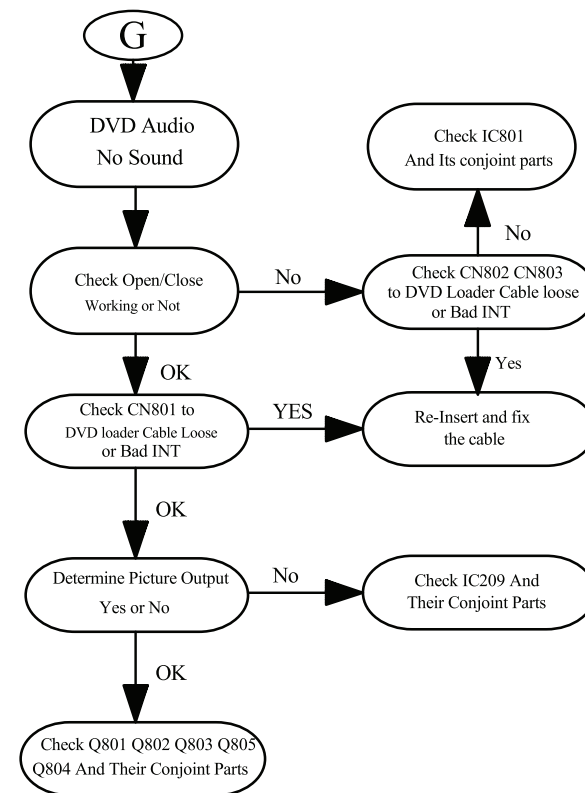
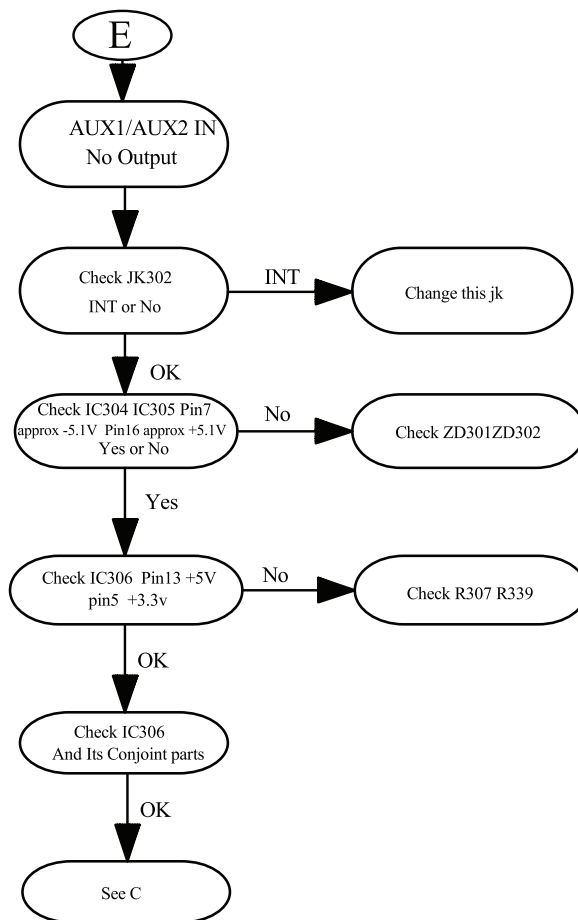
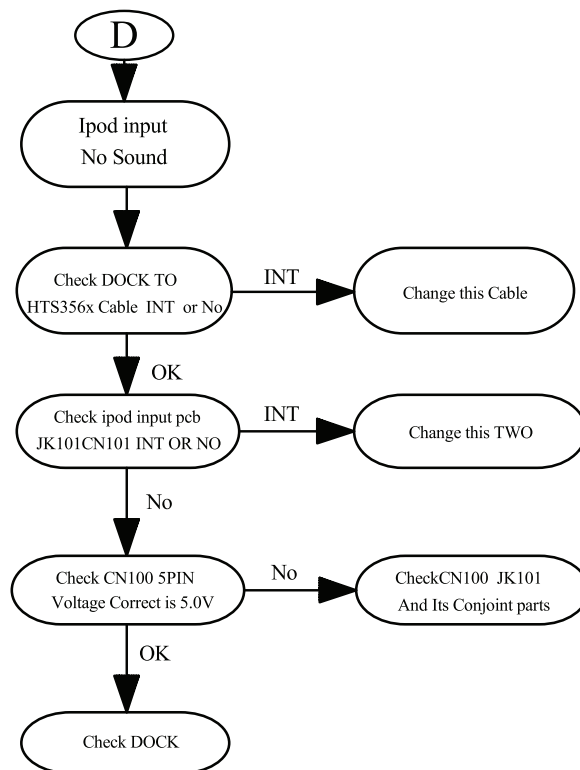

# MAIN UNIT REPAIR CHART 3/3

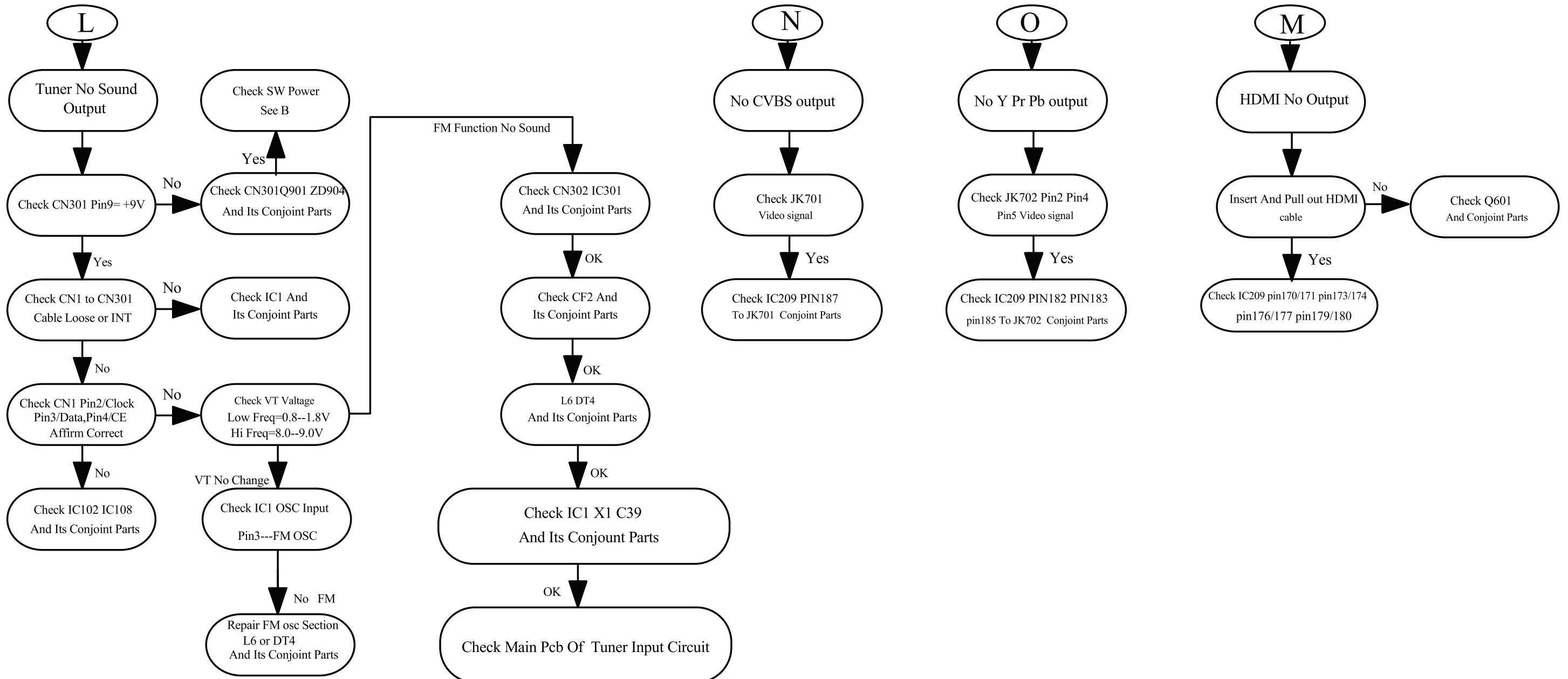



# DISASSEMBLY INSTRUCTIONS

## Dismantling of the Front Panel Assemble

- 1) Open the DVD Tray by using the Open/Close Button while the Set is ON and disconnect the mains supply after removing the Tray Cover.  
*Note: If this is not possible, the DVD Tray has to be open manually.*  
Take a mini screw driver about 2mm diameter and make a marking 24mm from the tip as shown in figure 2 . Place the set on its side, insert the mini screw driver till the marking and slide it towards the left as shown in figure 1 until the Tray moves out of the Front Panel.
- 2) Return the set to its upright position and remove the Tray Cover as shown in Figure 3 and close the tray manually by pushing it back in.

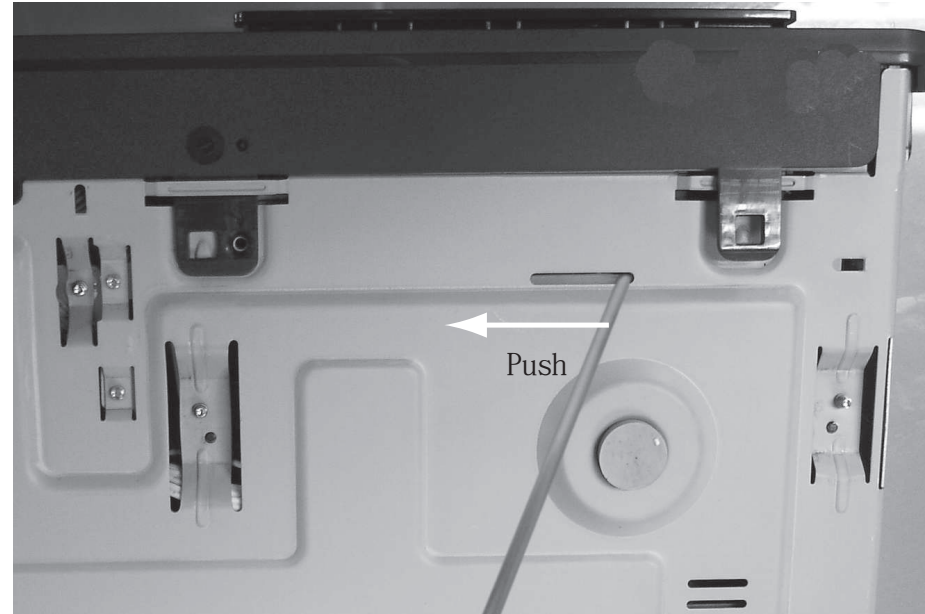

Figure 1



Figure 2

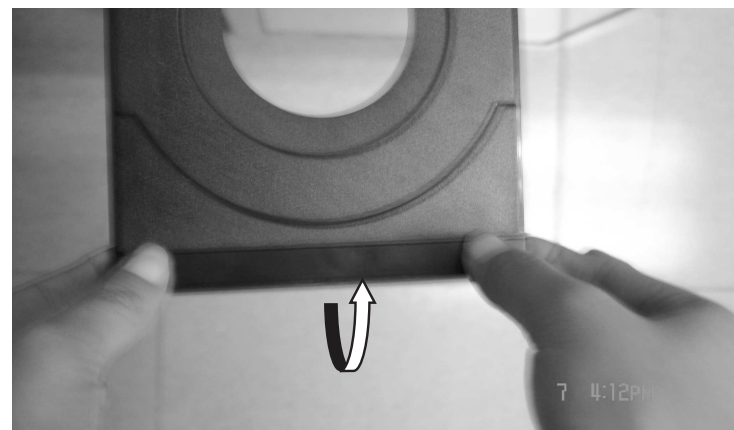

Figure 3

- 3) Loosen 6 screws and remove the Top Cover by lifting the rear portion upwards before sliding it out towards the rear.
  - 1 screw "A" each on the left & right side as shown in figure 4.
  - 4 screws "B" at the back panel as shown in figure 5.
- 4) Loosen 5 screws "C" at the front panel bracket as in figure 6 to remove the front panel.

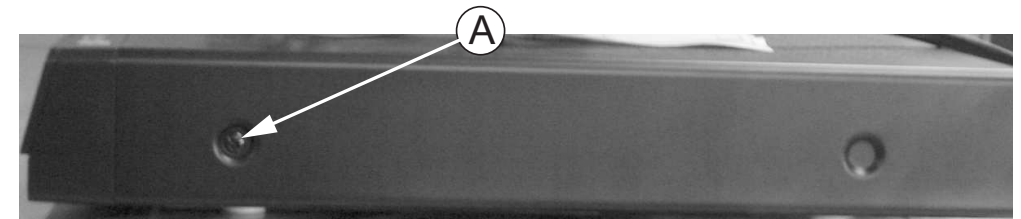

Figure 4

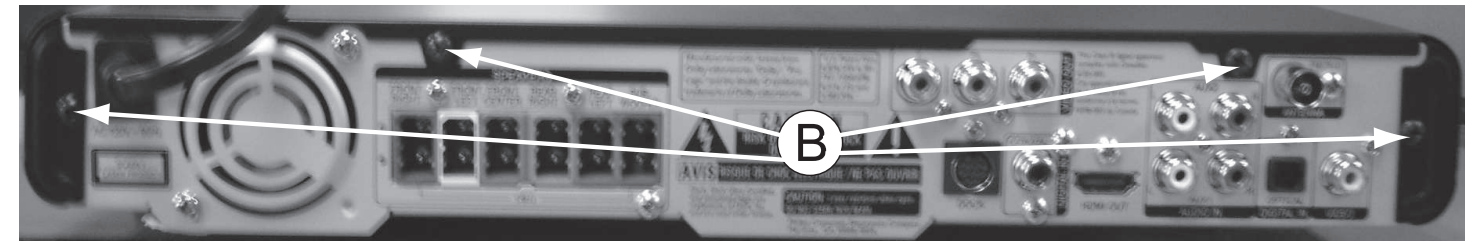

Figure 5

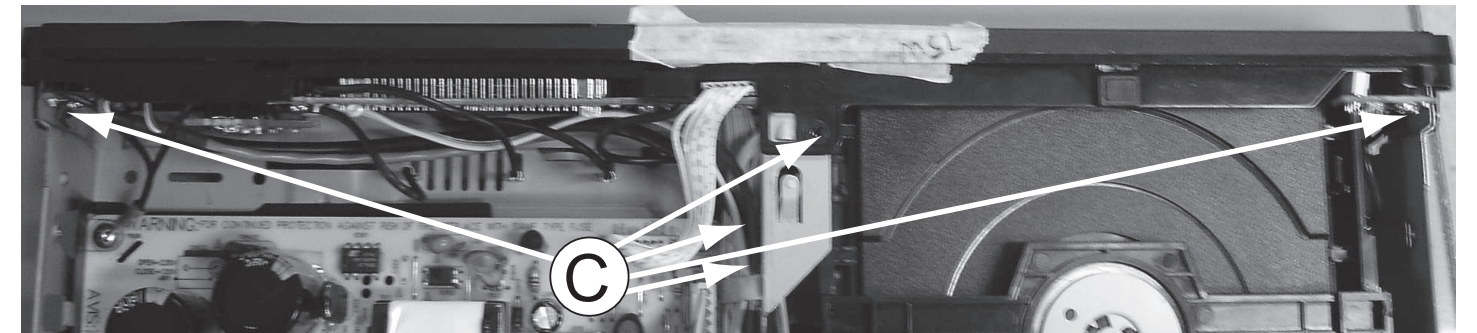

Figure 6

## Dismantling of the DVD Module

- 1) Loosen 4 screws "D" at the DVD Module as shown in figure 7.

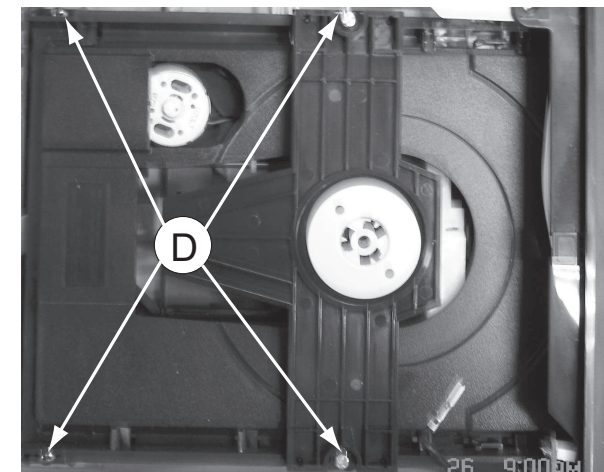

Figure 7



**Dismantling of the DISP+LED+VOL&MP3 IN Board**

- 1) Loosen 10 screws "E" on the top of DISP+LED+VOL&MP3 IN Board as shown in figure 8.

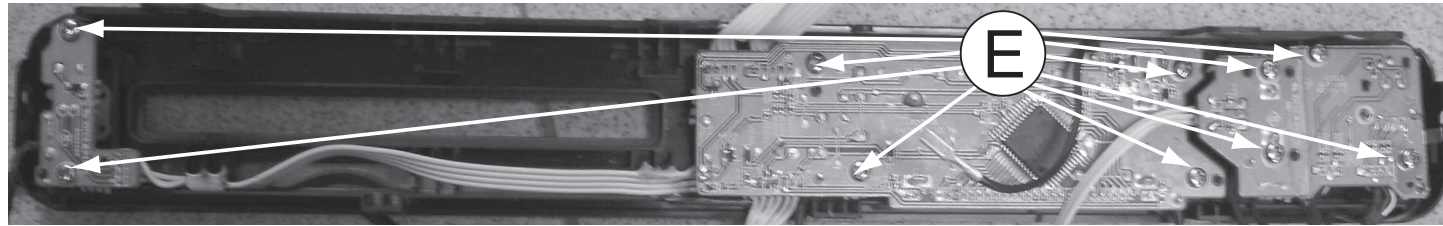

Figure 8

**Dismantling of the Power Board**

- 1) Loosen 4 screws "F" on the top of Power Board as shown in figure 9.
- 2) With a pincers to nip this space as shown in figure 10 and to take up the power board.

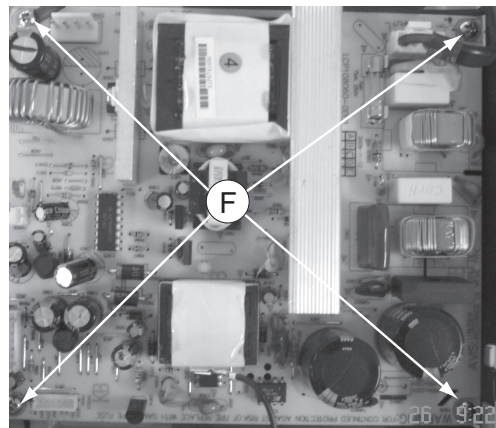

Figure 9

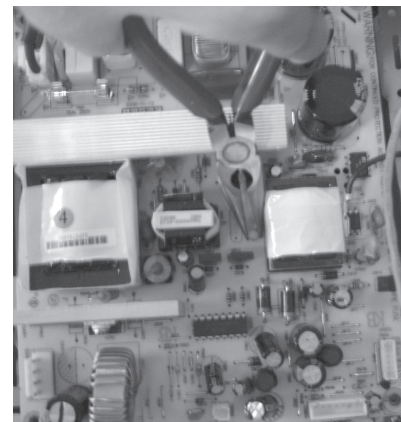

Figure 10

**Dismantling of the MAIN+Y.U.V Board**

- 1) Loosen 4 screws "G" on the top of Main Board as shown in figure 11.
- 2) Loosen 12 screws "H" at the back panel as shown in figure 12.

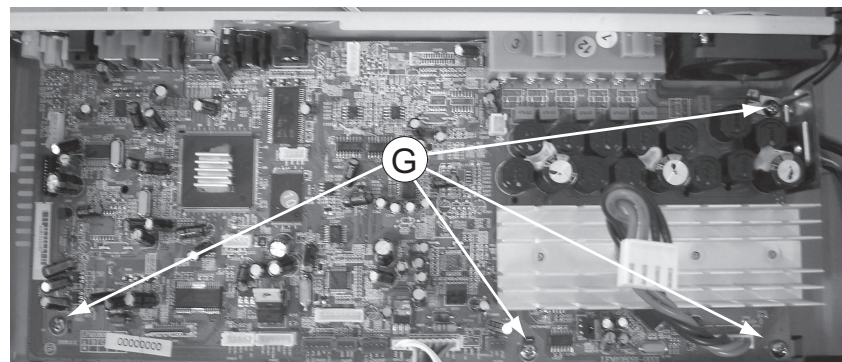

Figure 11



Figure 12

**SERVICE POSITIONS**

Service position A

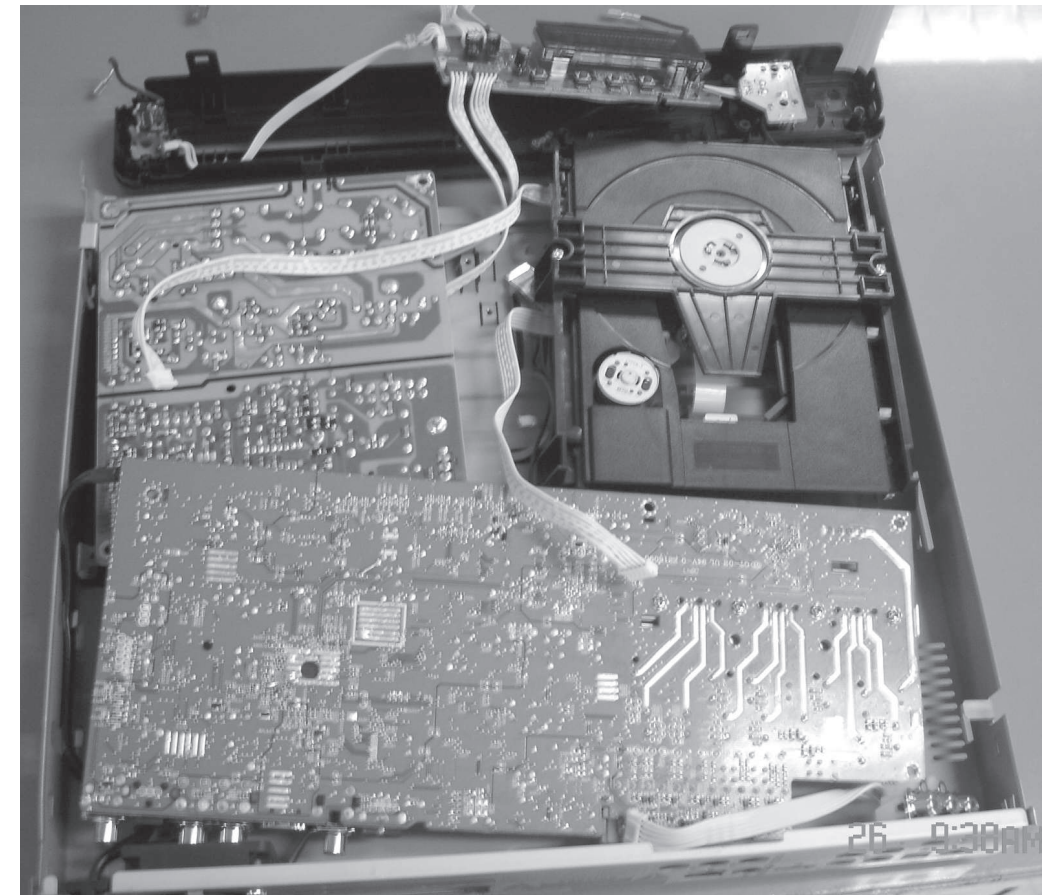

Note: In some service positions the components or copper patterns of one board may risk touching its neighbouring pc boards or metallic parts. To prevent such short-circuit use a piece of hard paper or other insulating material between them.

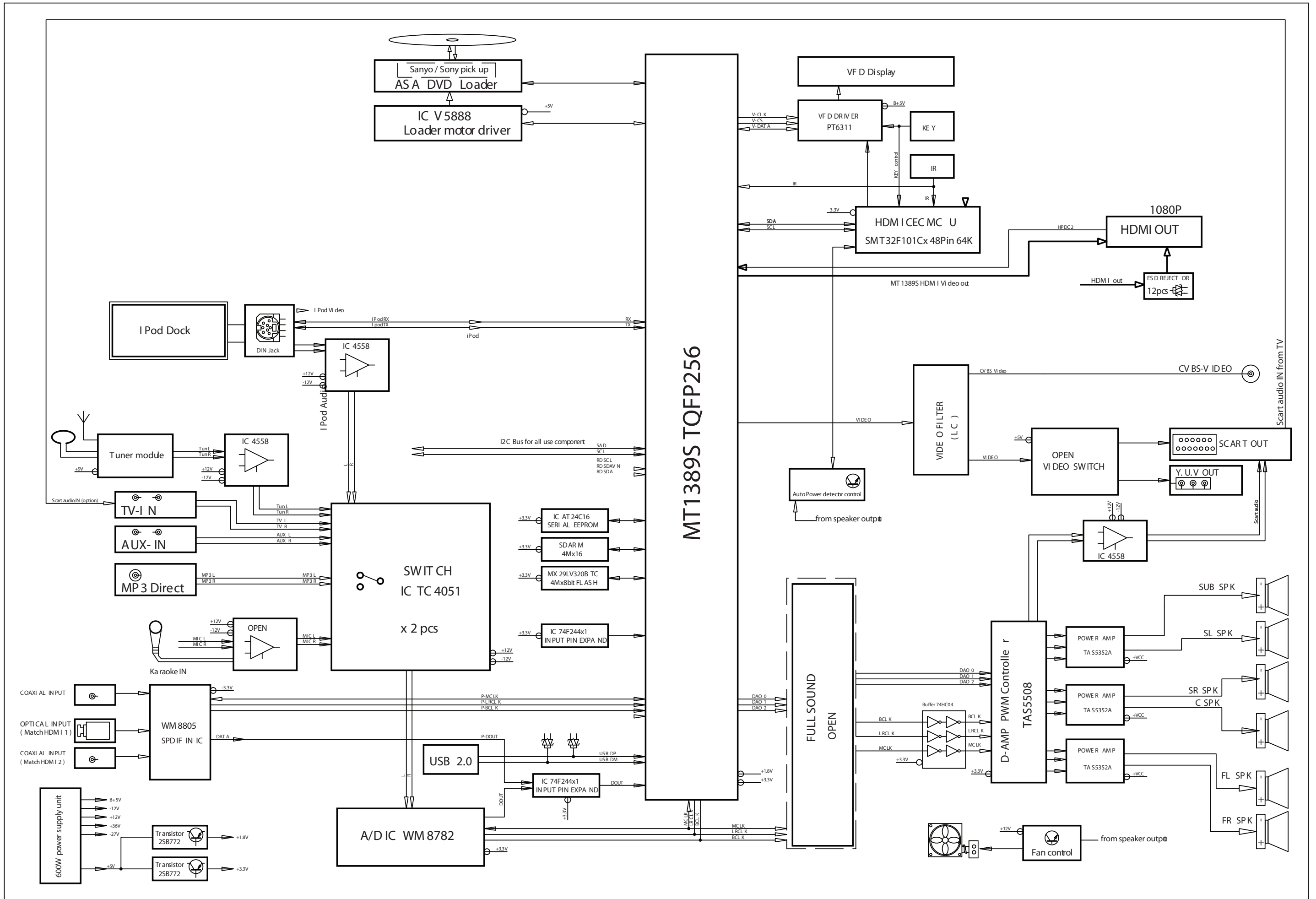



**FTD DISPLAY PIN ASSIGNMENT**

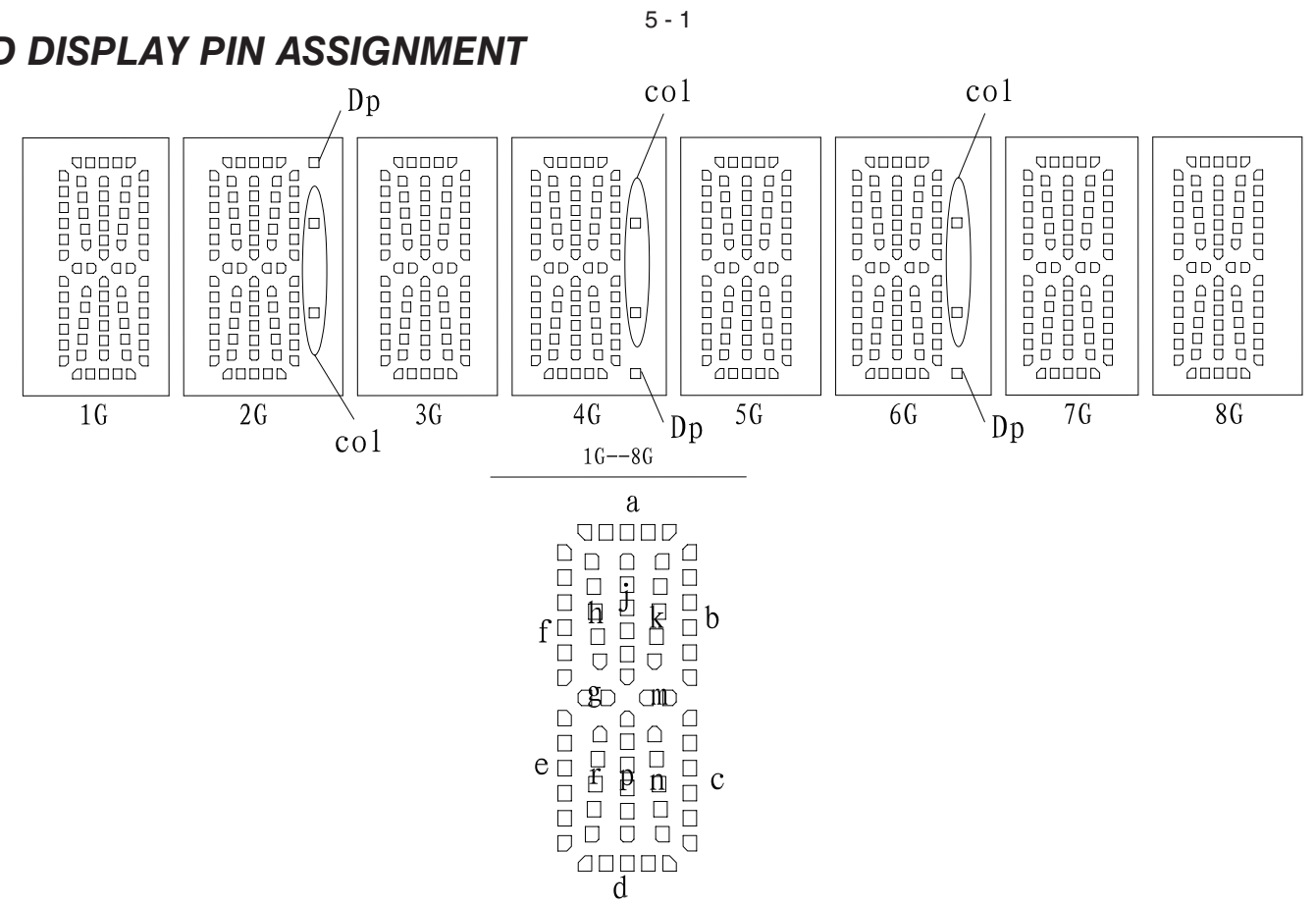

# DISP+LED+VOL BOARD

**TABLE OF CONTENTS**

FTD Display Pin Assignment.....5-1  
 Circuit Diagram .....5-2  
 PCB Layout Top & Bottom View.....5-3

	1G	2G	3G	4G	5G	6G	7G	8G
P1	a	a	a	a	a	a	a	a
P2	j, p	j, p	j, p	j, p	j, p	j, p	j, p	j, p
P3	h	h	h	h	h	h	h	h
P4	k	k	k	k	k	k	k	k
P5	b	b	b	b	b	b	b	b
P6	f	f	f	f	f	f	f	f
P7	m	m	m	m	m	m	m	m
P8	g	g	g	g	g	g	g	g
P9	c	c	c	c	c	c	c	c
P10	e	e	e	e	e	e	e	e
P11	r	r	r	r	r	r	r	r
P12	n	n	n	n	n	n	n	n
P13	d	d	d	d	d	d	d	d
P14	/	col	/	col	/	col	/	/
P15	/	Dp	/	Dp	/	Dp	/	/

**PIN CONNECTION**

管脚序号 (Pin NO.)	1	2	3	4	5	6	7	8	9	10	11	12	13	14	15	16
连接 (Connection)	F1	F1	NP	NC	P15	P14	NC	P13	P12	P11	P10	P9	P8	P7	P6	P5
管脚序号 (Pin NO.)	17	18	19	20	21	22	23	24	25	26	27	28	29	30	31	32
连接 (Connection)	P4	P3	P2	P1	NC	1G	2G	3G	4G	5G	6G	7G	8G	NP	F2	F2

注 (Notes) : Fn : 灯丝 (Filament Pin) nG : 栅极 (Grid Pin)  
 Pn : 阳极 (Anode Pin) NP : 无引出脚 (No Pin)  
 NC : 无功能 (No connection Pin)



C380 B1 C384 C1 C387 A2 C390 B2 C395 C4 DP351 A2 Q351 C1 R3051 B1 R3054 B1 R3057 C1 R3060 C1 R3063 B1 R3068 A3 R3072 C1 RB351 C4 RB357 C1 TA351 A1 TA354 C1 ZD310 C1 ZD313 B1  
 C381 B1 C385 C1 C388 A3 C391 B2 C396 C4 IC351 B2 Q352 C1 R3052 B1 R3055 B1 R3058 C1 R3061 B1 R3064 B1 R3069 B2 R3073 C1 RB355 B1 RB359 B1 TA352 C1 TA355 C1 ZD311 C2  
 C382 B1 C386 C1 C389 B2 C392 B1 C397 B1 LD351 A1 Q353 B1 R3053 B1 R3056 B1 R3059 C1 R3062 B1 R3067 A2 R3071 C1 R3077 C1 RB356 C1 SN351 C1 TA353 C1 VR351 C4 ZD312 C1

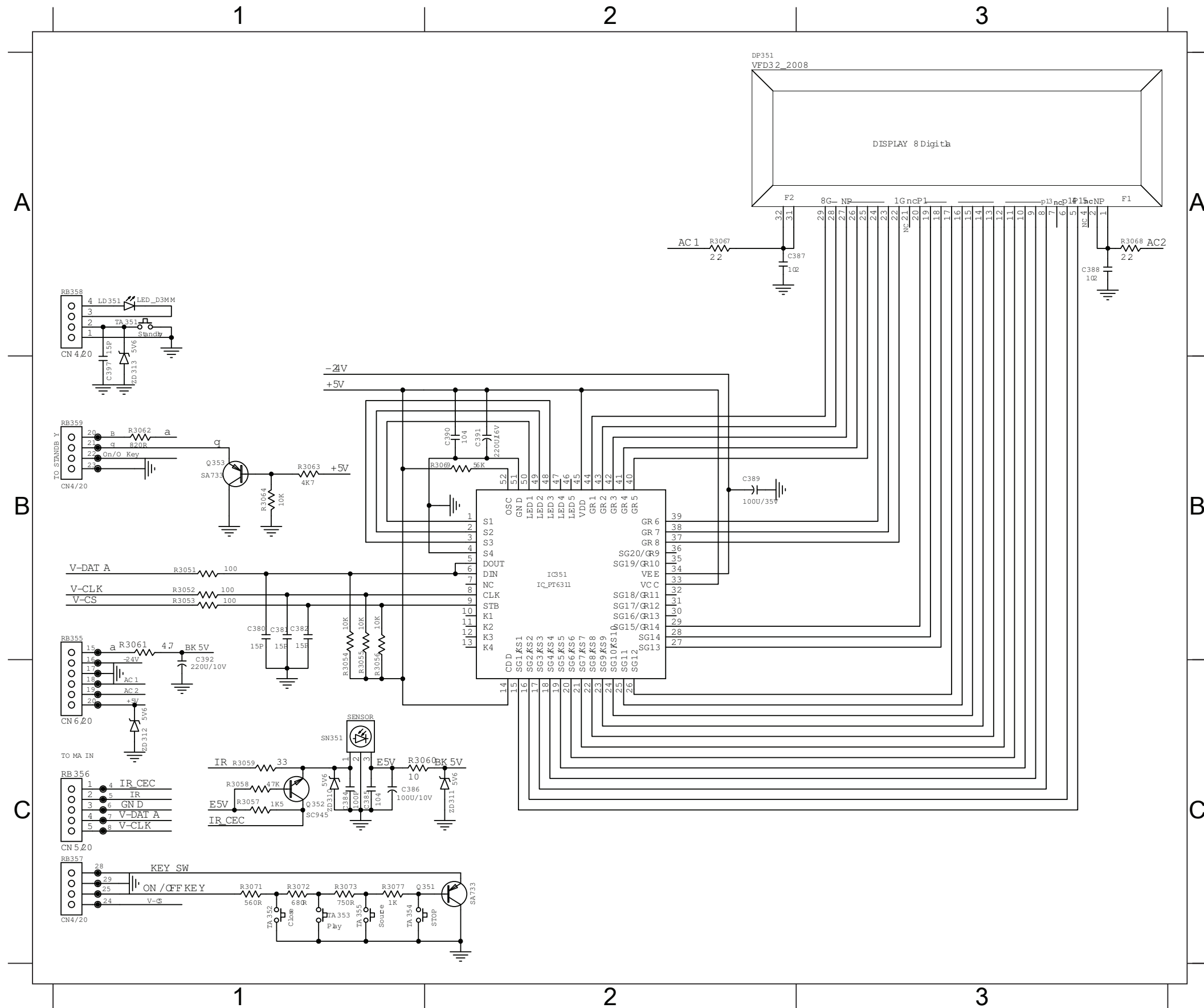

### PCB LAYOUT - TOP VIEW

C386 A3 C391 A1 DP351 A2 ESD4 A3 ESD6 A1 J351 A2 J353 A2 J355 A3 J357 B2 J359 A3 LD351 A1 RB355 A1 RB357 B1 SN351 B3 TA352 B2 TA354 B2 VR351 A3  
 C389 A1 C392 B2 ESD1 A2 ESD5 B3 ESD7 A3 J352 B1 J354 B1 J356 A3 J358 A2 J363 A1 RB351 A3 RB356 B1 RB359 A1 TA351 B1 TA353 B2 TA355 B2

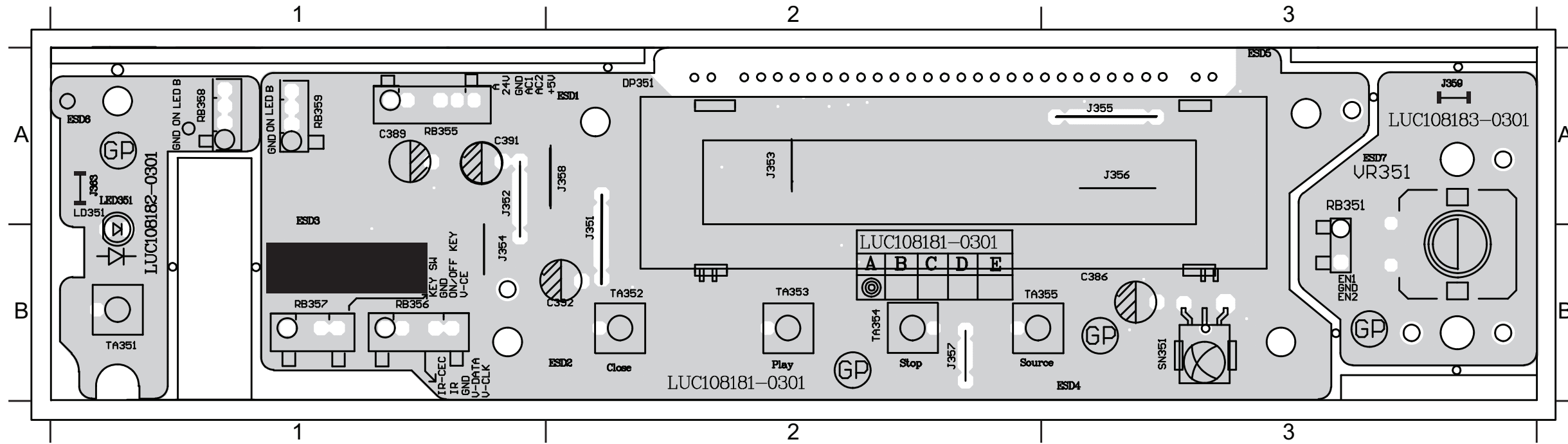

### PCB LAYOUT - BOTTOM VIEW

C380 B2 C382 B2 C387 A1 C390 A3 C396 A1 IC351 A2 Q352 B1 R3051 B3 R3053 B3 R3055 A3 R3057 B1 R3059 B1 R3061 A3 R3063 A3 R3067 A1 R3069 B1 R3072 B2 R3077 B2 ZD311 A3 ZD313 B3  
 C381 B2 C385 B1 C388 A2 C395 B1 C397 B3 Q351 B3 Q353 A3 R3052 B3 R3054 A3 R3056 A3 R3058 B1 R3060 B1 R3062 A3 R3064 A3 R3068 A2 R3071 B3 R3073 B2 ZD310 B1 ZD312 A2

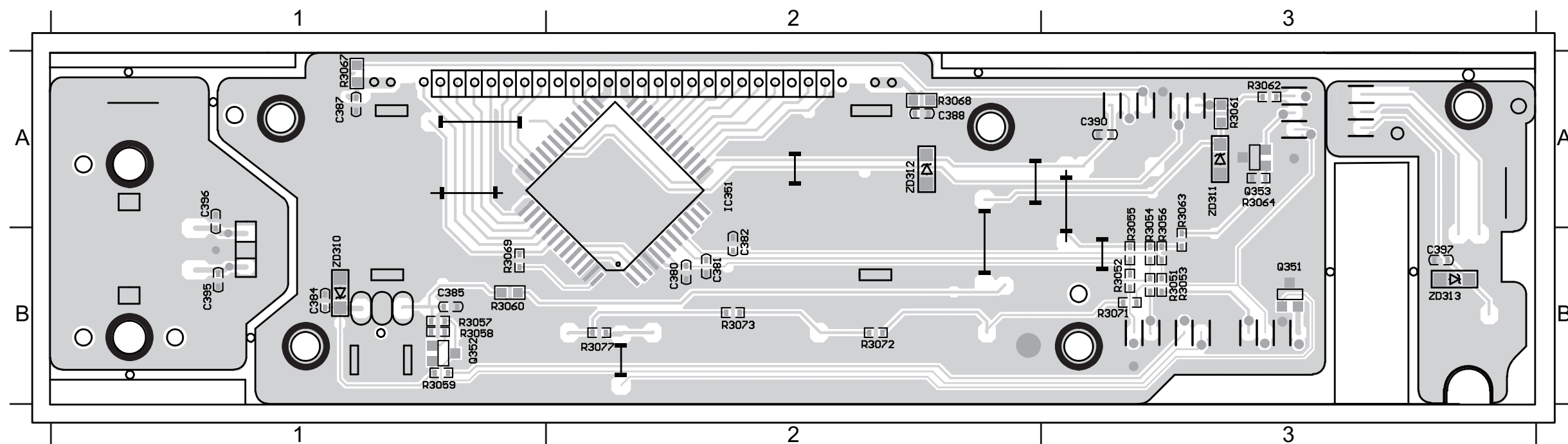

# MAIN BOARD

## TABLE OF CONTENTS

- Internal IC Diagram ..... 6-1
- Circuit Diagram(part one) ..... 6-2
- Circuit Diagram(part two)..... 6-3
- Circuit Diagram(part three) ..... 6-4
- PCB Layout Top View ..... 6-5
- PCB Layout Bottom View ..... 6-6

## INTERNAL IC DIAGRAM - TAS5508B

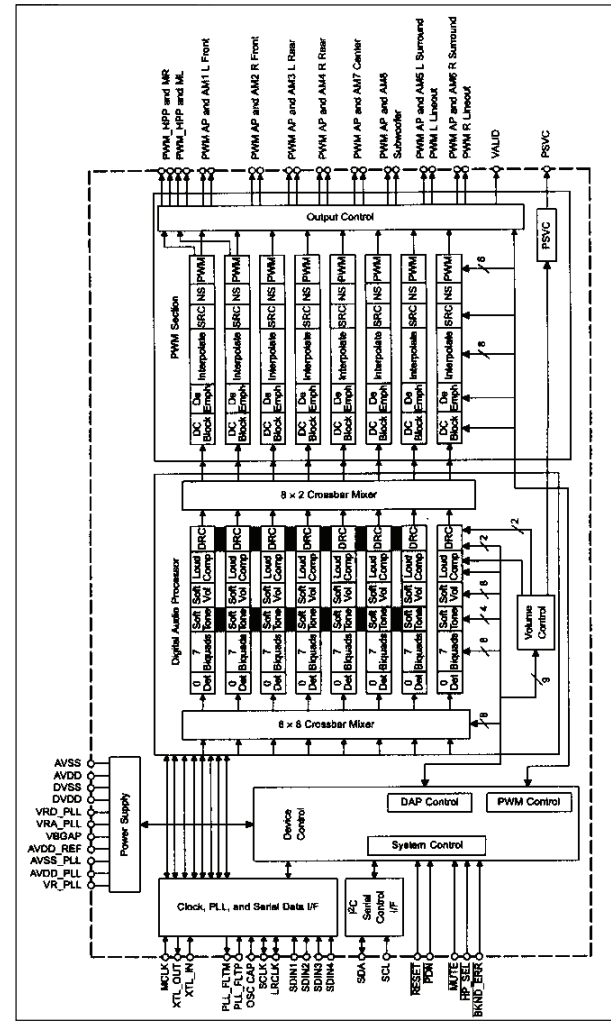

## INTERNAL IC DIAGRAM - HY57V641620F

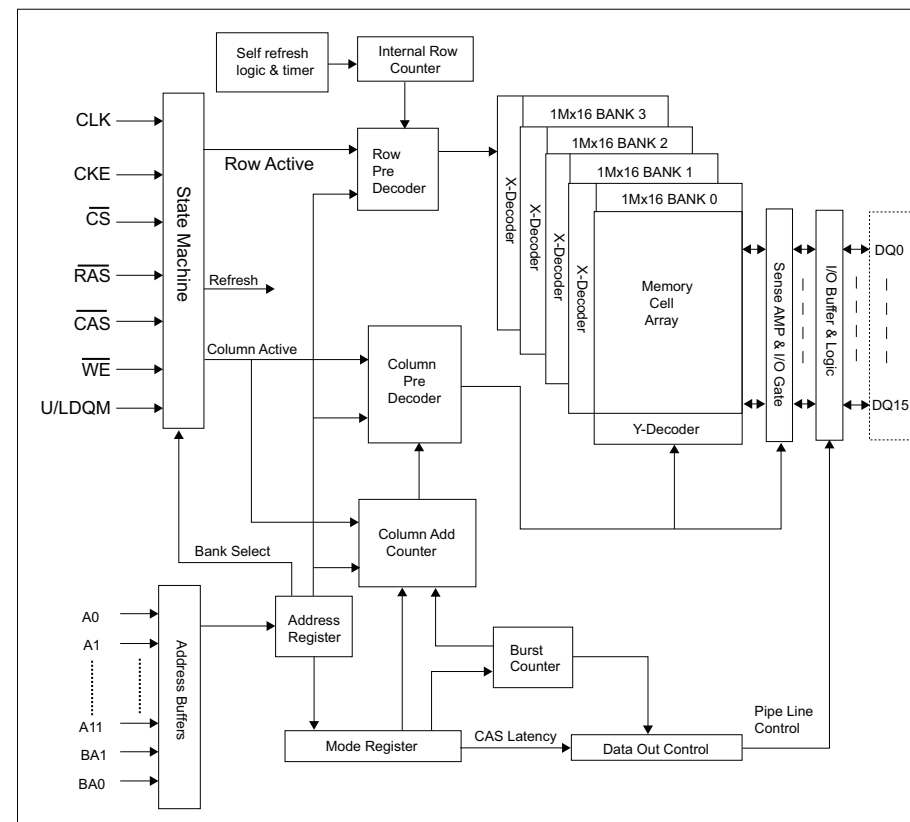

# CIRCUIT DIAGRAM - part one

C4000B4 C4010B3 C4023B4 C4035A4 C4045A4 C407 B1 C409 B1 C421 B1 C434 D3 C447 D4 C460 D4 C471 B3 C484 C4 C497 B4 D410 D2 IC406 D2 L409 B4 Q407 D1 R4028D2 R4038D2 R4048D1 R4062D2 R417 B2 R431 C3 R442 D4 R454 B3 R465 C4 R477 A3 R488 A4  
 C4001B4 C4011B4 C4024A4 C4036A4 C405 A1 C4070D2 C410 B1 C422 B1 C435 D4 C448 D4 C461 C4 C472 C3 C485 C4 C498 B4 D411 D2 IC407 C1 L410 A4 Q408 D1 R4029D2 R4039D2 R4049D1 R407 B1 R418 B2 R432 C3 R443 D4 R455 B3 R466 B4 R478 A3 R489 A4  
 C4002B4 C4012B4 C4025B4 C4037A4 C406 B1 C4071D1 C411 B1 C423 B2 C436 D4 C449 D4 C462 D4 C473 C3 C486 C4 C499 B4 D412 D2 JK401B4 L411 A4 Q409 D1 R403 B1 R404 B1 R405 B1 R408 B1 R419 B2 R433 D3 R444 D4 R456 C3 R467 B4 R479 A3 R490 A4  
 C4003B4 C4013A4 C4026B4 C4038A4 C4062D2 C4072D1 C412 B1 C424 B2 C437 D4 C450 D4 C463 C4 C474 C4 C487 C4 C528 A2 D413 D1 L401 D4 L412 A4 Q410 D1 R4030D2 R4040D2 R4050D1 R409 B1 R420 B2 R434 D3 R445 D4 R457 C3 R468 B4 R480 B3 R491 A4  
 C4004B4 C4014A4 C4027B4 C4039A4 C4063D2 C4073C1 C413 B1 C425 A1 C438 D4 C451 D4 C464 C4 C475 C4 C488 C4 C589 C4 D414 D1 L402 D4 L413 D4 Q411 C1 R4031D2 R4041D1 R4051D1 R410 B2 R421 B2 R435 D3 R446 D4 R458 C3 R469 B4 R481 B3 R492 A4  
 C4005B4 C4015A4 C4028A4 C404 A1 C4064D2 C4075C2 C414 B1 C427 C2 C439 D4 C452 D4 C465 C4 C476 B4 C489 C4 C590 C4 D415 C1 L403 D4 L414 C4 R401 A1 R4032D2 R4042D1 R4052C1 R411 B2 R422 B2 R436 D3 R447 D4 R459 C3 R470 B4 R482 B4 R493 A4  
 C4006B4 C4018A4 C4029A4 C4040A4 C4065D2 C4076C2 C415 B1 C428 C2 C442 D4 C453 D4 C466 D4 C477 C4 C490 B4 CN401D1 FB401C2 L404 C4 L415 C4 R402 A1 R4033D2 R4043D1 R4053C1 R412 B2 R423 A1 R437 D3 R448 C4 R460 C4 R471 B4 R483 C4 RB401D1  
 C4007A3 C402 A1 C403 A1 C4041A4 C4066D2 C4078C2 C416 B1 C429 C2 C443 D4 C454 C4 C467 D4 C478 C4 C491 B4 D406 D2 IC401 A2 L405 C4 L416 B4 R4024D2 R4034D2 R4044D1 R4054C1 R413 B2 R424 A1 R438 D3 R449 C4 R461 C4 R472 A3 R484 B4 RB402C1  
 C4008A3 C4020A4 C4030A4 C4042A4 C4067D2 C408 B1 C417 B1 C431 C3 C444 D4 C455 C4 C468 D4 C481 C4 C492 B4 D407 D2 IC402 C3 L406 B4 L417 A4 R4025D2 R4035D2 R4045D1 R4056C1 R414 B2 R425 A1 R439 D4 R450 B3 R462 C4 R474 A3 R485 B4 XL401B1  
 C4009B3 C4021B4 C4031A4 C4043A4 C4068D2 C4080A4 C419 B1 C432 D3 C445 D4 C456 D4 C469 C4 C482 C4 C493 B4 D408 D2 IC403 B3 L407 B4 L418 A4 R4026D2 R4036D2 R4046D1 R406 B1 R415 B2 R426 C2 R440 D4 R452 B3 R463 C4 R475 A3 R486 B4 ZD309C1  
 C401 A1 C4022A4 C4032A4 C4044A4 C4069D2 C4081C4 C420 B1 C433 D3 C446 D4 C457 C4 C470 B3 C483 C4 C496 B4 D409 D2 IC404 A3 L408 B4 Q405 C2 R4027D2 R4037D2 R4047D1 R4061D2 R416 B2 R429 C3 R441 D4 R453 B3 R464 C4 R476 A3 R487 A4 ZD401C2

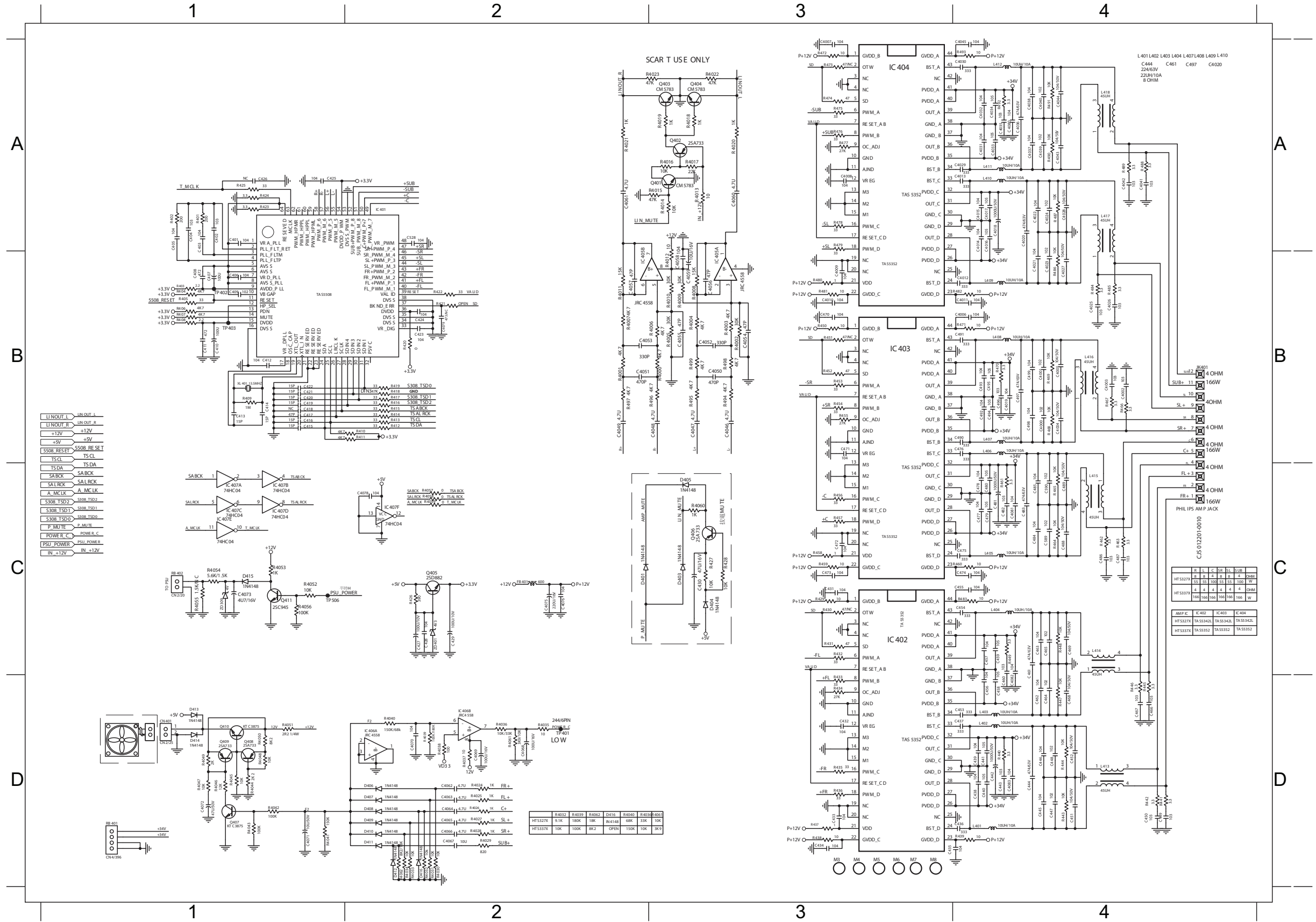

- LINOUT\_L LINOUT\_L
- LINOUT\_R LINOUT\_R
- +12V +12V
- +5V +5V
- SS08 RESET SS08 RESET
- TSCL TSCL
- TSDA TSDA
- SARCK SARCK
- SALRCK SALRCK
- A\_MCLK A\_MCLK
- SS08\_TS01 SS08\_TS01
- SS08\_TS02 SS08\_TS02
- SS08\_TS03 SS08\_TS03
- SS08\_TS04 SS08\_TS04
- P\_RESET P\_RESET
- POWER\_C POWER\_C
- PSU\_POWER PSU\_POWER
- IN +12V IN +12V

- HT53278
- HT53279
- HT53278
- HT53279

- AMP\_C
- HT53278
- HT53279

- HT53278
- HT53279

- HT53278
- HT53279

- HT53278
- HT53279

HT53278	HT53279	HT53278	HT53279
10K	10K	10K	10K
10K	10K	10K	10K
10K	10K	10K	10K

AMP_C	HT53278	HT53279
10K	10K	10K
10K	10K	10K
10K	10K	10K

AMP_C	HT53278	HT53279
10K	10K	10K
10K	10K	10K
10K	10K	10K

AMP_C	HT53278	HT53279
10K	10K	10K
10K	10K	10K
10K	10K	10K

AMP_C	HT53278	HT53279
10K	10K	10K
10K	10K	10K
10K	10K	10K



# CIRCUIT DIAGRAM - part two

C0201	C2	C0217	D1	C0241	D4	C0606	C4	C211	D4	C229	C1	C260	D1	C711	A3	C737	A3	C817	B2	C833	B2	CE204	D1	CE806	D1	CO254	A2	FB210	C1	FB706	A3	IC209	B3	L703	B3	Q707	A3	R211	C4	R229	D1	R252	C1	R272	D2	R293	D2	R732	B3	R807	C2	R833	B2	XL203	C1
C0202	A2	C0218	D1	C0242	D4	C101	A4	C213	C1	C230	D2	C261	D1	C713	A3	C738	C2	C818	A2	C834	B1	CE205	D1	CE807	D1	D201	A3	FB211	C1	FB707	C2	IC210	A3	L704	B3	Q708	A3	R212	C4	R230	C1	R253	C1	R274	A4	R294	B2	R733	B3	R808	A1	R834	B2	ZD209	B4
C0203	A2	C0219	D1	C0243	D4	C102	A4	C214	C2	C231	D2	C262	C4	C716	B3	C801	A1	C819	B1	C835	A1	CE206	D1	CE808	D1	D202	D1	FB212	C1	FB708	C2	IC801	B1	L707	A3	Q801	A1	R213	D2	R231	C1	R254	D4	R276	D2	R296	D1	R734	B3	R812	A1	R835	B2		
C0204	D1	C0220	D1	C0244	A2	C105	A4	C215	A2	C232	C1	C601	C4	C717	B3	C802	A2	C820	B2	C836	A2	CE207	D1	CE809	D1	D204	A3	FB213	C1	FB712	A4	JK601	B4	L801	A2	Q802	A1	R215	D2	R232	C1	R256	D1	R277	D2	R297	D1	R737	A3	R813	A1	R836	B1		
C0205	A2	C0221	D1	C0245	A2	C107	B4	C216	B2	C233	D1	C602	C4	C718	B3	C803	B1	C821	B2	C837	A2	CE212	C1	CN201	B4	D205	D3	FB214	C1	FB715	A3	JK701	A3	L802	A2	Q803	A1	R216	D1	R233	D2	R257	D1	R278	D2	R298	D1	R738	C2	R814	A2	R838	B2		
C0206	A2	C0222	D1	C0246	A2	C109	A4	C217	A2	C237	B3	C603	B4	C719	A3	C804	B2	C822	B2	C838	B2	CE215	C2	CN202	C1	D600	D1	FB216	C2	FB801	A1	JK702	A3	L803	B2	Q804	A2	R217	D1	R234	C1	R258	D1	R279	C1	R299	D1	R748	A3	R815	A2	R839	B2		
C0207	A3	C0226	D1	C0247	A2	C201	A4	C218	B4	C238	B3	C701	A3	C720	B3	C805	B1	C823	B1	C839	B2	CE216	C2	CN203	D3	F201	B4	FB217	A2	FB802	A1	JK704	A3	Q204	A3	Q805	A1	R218	D2	R235	B1	R259	D2	R280	B3	R601	D1	R750	A4	R816	A1	R840	B2		
C0208	A3	C0227	C2	C0248	B4	C202	B4	C219	A3	C239	D1	C702	A3	C721	A3	C806	B1	C824	B2	C840	B2	CE217	C2	CN204	D2	FB201	A2	FB220	C1	FB803	B1	L201	A2	Q205	D1	R201	C4	R219	A3	R236	B1	R260	D2	R281	D3	R603	C4	R751	A3	R817	B2	R841	B2		
C0209	A2	C0228	D1	C0249	A2	C203	A2	C220	A3	C242	B2	C703	A3	C722	A3	C807	B1	C825	A2	C841	B2	CE218	C2	CN205	C1	FB202	A2	FB222	C1	IC201	D3	L202	A2	Q206	D1	R202	B4	R220	C4	R238	D4	R261	D2	R285	D2	R604	B4	R752	A3	R820	A1	R842	B2		
C0210	B4	C0229	D1	C0251	C4	C204	B2	C221	B4	C243	D1	C704	A3	C723	B3	C808	B2	C826	B2	C843	B1	CE219	C2	CN206	B4	FB203	A2	FB226	A2	IC202	C4	L203	A2	Q207	D1	R203	D1	R221	C4	R239	D3	R262	D2	R286	D2	R605	B4	R754	A4	R822	A2	R845	C2		
C0211	A2	C0230	D1	C0252	C4	C205	C4	C223	D1	C250	D2	C705	A3	C728	A4	C809	B2	C827	B2	C844	B2	CE220	C2	CN208	C1	FB204	A2	FB601	A3	IC203	D3	L204	D4	Q300	D3	R204	D1	R222	D3	R242	D1	R264	D2	R287	D2	R606	C4	R801	C2	R823	A2	RA201	C2		
C0212	C2	C0235	D2	C0253	B4	C206	B3	C224	D1	C253	C1	C706	A3	C730	A3	C810	A2	C828	B2	C846	C2	CE801	D1	CN701AA3	FB205	C4	FB602	C4	IC204	D2	L205	B4	Q601	B4	R205	C1	R223	D3	R245	C1	R267	D2	R288	D2	R702	A3	R802	A1	R824	A2	RA202	C4			
C0213	C4	C0237	D4	C0601	C4	C207	D3	C225	C1	C254	D3	C707	A3	C731	A4	C811	A2	C829	B2	C849	B2	CE802	D1	CN702	A2	FB206	C4	FB603	C4	IC205	A2	L206	B3	Q602	A3	R207	A3	R224	D3	R248	C1	R269	D2	R289	D1	R704	A3	R803	A1	R826	B1	RA203	C2		
C0214	C4	C0238	D4	C0602	C4	C208	A2	C226	C1	C255	D1	C708	A3	C732	A3	C812	A2	C830	B2	CE201	D1	CE803	D1	CN801	A1	FB207	D4	FB703	A3	IC206	D4	L207	B4	Q611	B4	R208	D2	R225	B4	R249	C1	R268	D1	R290	B1	R705	A3	R804	B1	R827	B1	RB701	A2		
C0215	C2	C0239	D4	C0603	C4	C209	B3	C227	C1	C256	D1	C709	A3	C735	C2	C813	B2	C831	B2	CE202	D1	CE804	D1	CN802	B1	FB208	D4	FB704	A3	IC207	D4	L701	B3	Q705	A3	R209	B4	R227	D2	R250	D3	R270	D2	R291	C1	R724	A4	R805	B1	R829	B1	XL201	B3		
C0216	D1	C0240	D4	C0604	C4	C210	C2	C228	C2	C257	D1	C710	A3	C736	A3	C816	B2	C832	B2	CE203	D1	CE805	D1	CN803	B1	FB209	C1	FB705	A3	IC208	D2	L702	B3	Q706	A3	R210	C4	R228	D1	R251	C1	R271	D1	R292	C1	R731	B3	R806	C2	R831	B2	XL202	D1		

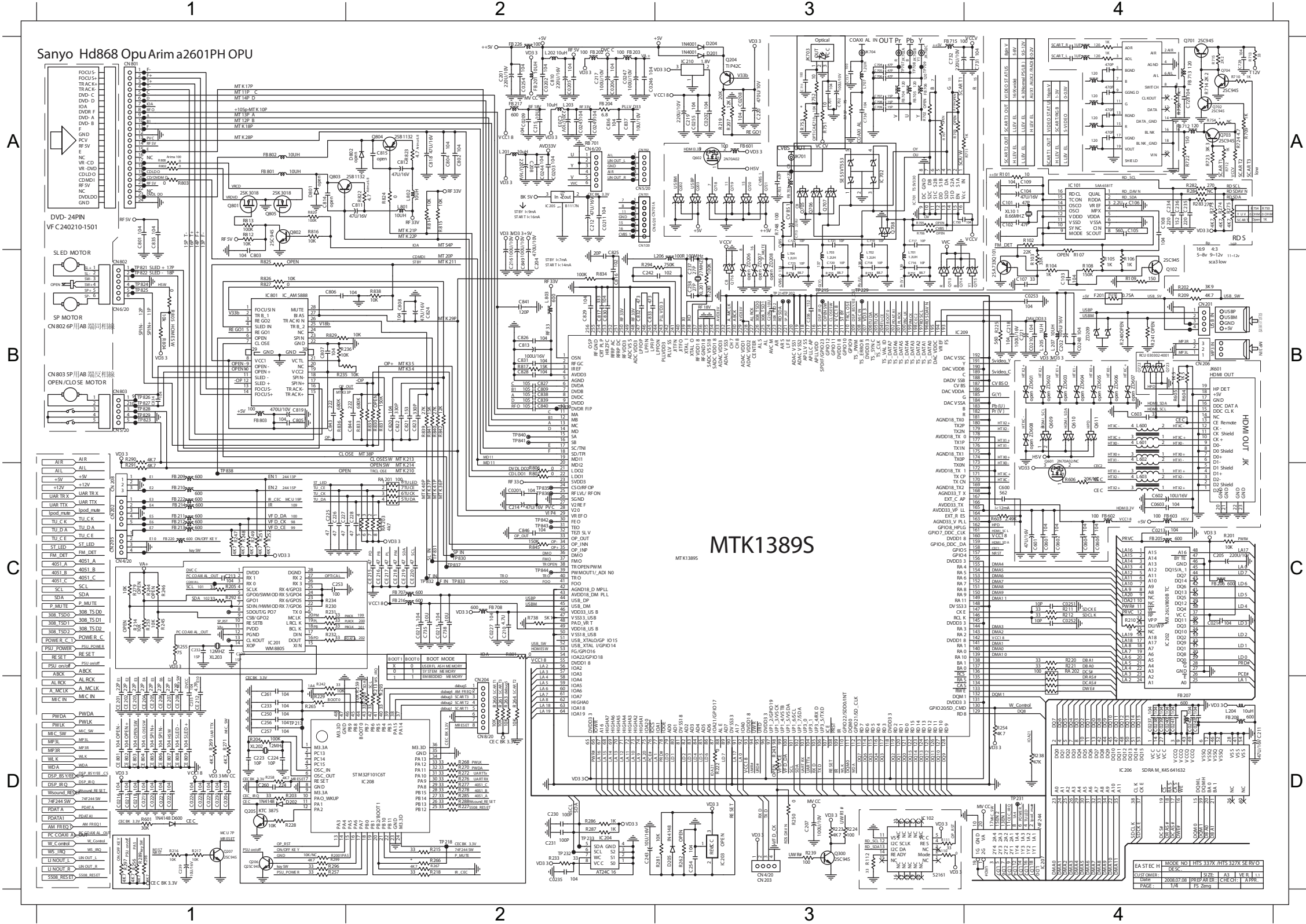

# CIRCUIT DIAGRAM - part three

C301 A1 C313 A2 C324 B3 C334 B2 C351 B3 C366 A1 C515 B4 C908 D2 C932 D1 CE309 D2 CE319 D2 CE329 D3 CE904 D1 FE302 D3 IC304 A2 Q305 A3 R3020 B2 R311 A1 R321 A2 R331 A3 R351 B1 R361 B3 R390 B3 R558 B4 ZD302 A2  
 C302 A1 C315 A2 C325 A1 C340 A3 C352 B1 C506 B4 C516 B4 C912 D2 C935 D2 CE310 D2 CE320 D2 CE330 D3 CN301 A1 FE306 D3 IC305 B2 Q507 A1 R3021 B1 R312 B1 R322 A2 R332 B2 R352 B1 R368 B1 R399 B3 R560 C4 ZD901 D1  
 C303 B1 C316 A2 C326 A1 C341 B2 C353 B1 C507 B4 C517 B4 C918 D2 CE301 D2 CE311 D2 CE321 D2 CE345 A1 FB223 D1 FE307 D3 IC306 B3 Q508 A1 R3022 B1 R313 A1 R323 B2 R334 A3 R353 B1 R369 B1 R529 A4 R904 D1 ZD902 D1  
 C304 A1 C317 A3 C327 A1 C342 A2 C354 B1 C508 B4 C901 D1 C919 D2 CE302 D2 CE312 D2 CE322 D2 CE346 A1 FB302 A1 FE308 D3 IC309 A3 Q724 A1 R303 A1 R314 A1 R324 A2 R335 B3 R354 B1 R375 A1 R530 A4 R911 D1 ZD904 D1  
 C305 A1 C318 D3 C328 B1 C343 A2 C355 B1 C509 B4 C902 D1 C920 D1 CE303 D2 CE313 D2 CE323 D2 CE347 A1 FB310 A3 FE309 D3 JK301 A1 Q901 D1 R304 B1 R315 A1 R325 A2 R336 B3 R355 B1 R378 B3 R531 A4 R913 D1  
 C306 A1 C319 D4 C329 A2 C345 A1 C356 B1 C510 B4 C903 D1 C921 D1 CE304 D2 CE314 D2 CE324 D3 CE348 A1 FB312 B1 FE310 D3 JK302 B1 Q903 D1 R305 A3 R316 A1 R326 A2 R343 A2 R356 B1 R385 A1 R532 A4 R924 C2  
 C307 B1 C320 B3 C330 A2 C346 B3 C357 B1 C511 B4 C904 D1 C922 D1 CE305 D2 CE315 D2 CE325 D3 CE351 A1 FB313 B1 FE311 D3 L302 A1 R301 A1 R307 B3 R317 A1 R327 A2 R344 B2 R357 B1 R386 A1 R533 A4 R928 D1  
 C308 A1 C321 B3 C331 A3 C348 A1 C360 C4 C512 B4 C905 D1 C924 D1 CE306 D2 CE316 D2 CE326 D3 CE352 D3 FB901 D1 FE312 D3 L501 B4 R3018 A3 R308 A3 R318 A1 R328 B2 R348 B1 R358 B1 R387 A1 R546 A1 R929 D1  
 C309 A2 C322 B3 C332 A2 C349 B3 C362 B3 C513 B4 C906 D1 C928 D1 CE307 D2 CE317 D2 CE327 D3 CE901 D2 FB905 C1 IC301 A1 L502 B4 R3019 A2 R309 A1 R319 A1 R329 A2 R349 B1 R359 B1 R388 A1 R552 B4 RB901 C1  
 C311 A2 C323 A3 C333 B2 C350 B3 C363 B3 C514 B4 C907 D1 C929 D1 CE308 D2 CE318 D2 CE328 D3 CE903 D1 FE301 D3 IC302 A1 L503 B4 R302 A1 R310 A1 R320 B1 R330 A2 R350 B1 R360 A2 R389 B3 R553 B4 ZD301 A2

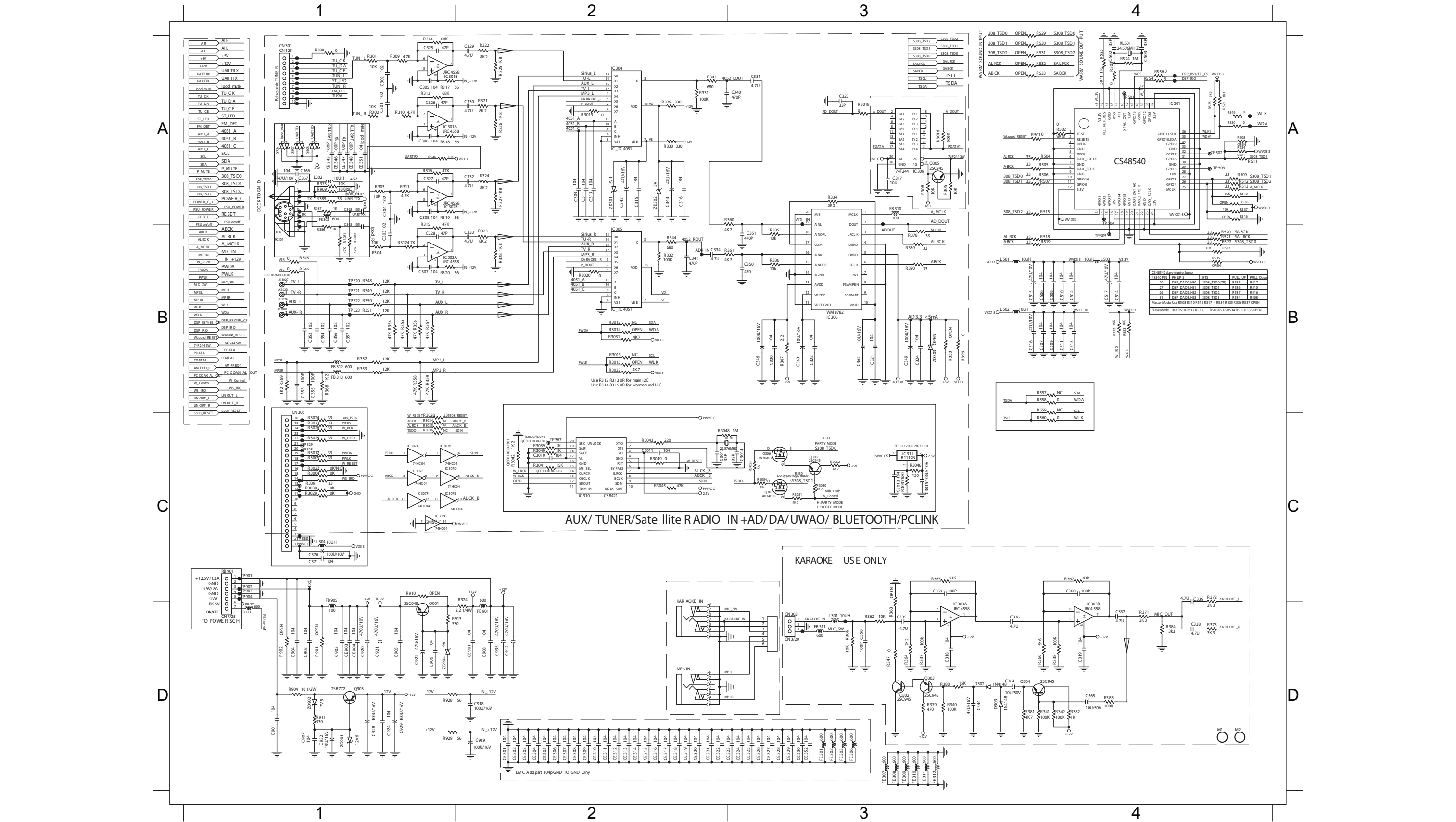

AUX/ TUNER/Sate Ilite RADIO IN +AD/DA/UWAO/ BLUETOOTH/PCLINK

KARAOKE USE ONLY

CS48540 Pin	Pin	Pin	Pin
20	QSP	QSP	R517
21	QSP	QSP	R518
22	QSP	QSP	R519
23	QSP	QSP	R520
24	QSP	QSP	R521
25	QSP	QSP	R522
26	QSP	QSP	R523
27	QSP	QSP	R524
28	QSP	QSP	R525
29	QSP	QSP	R526
30	QSP	QSP	R527
31	QSP	QSP	R528
32	QSP	QSP	R529
33	QSP	QSP	R530
34	QSP	QSP	R531
35	QSP	QSP	R532
36	QSP	QSP	R533
37	QSP	QSP	R534
38	QSP	QSP	R535
39	QSP	QSP	R536
40	QSP	QSP	R537
41	QSP	QSP	R538
42	QSP	QSP	R539
43	QSP	QSP	R540
44	QSP	QSP	R541
45	QSP	QSP	R542
46	QSP	QSP	R543
47	QSP	QSP	R544
48	QSP	QSP	R545
49	QSP	QSP	R546
50	QSP	QSP	R547
51	QSP	QSP	R548
52	QSP	QSP	R549
53	QSP	QSP	R550
54	QSP	QSP	R551
55	QSP	QSP	R552
56	QSP	QSP	R553
57	QSP	QSP	R554
58	QSP	QSP	R555
59	QSP	QSP	R556
60	QSP	QSP	R557
61	QSP	QSP	R558
62	QSP	QSP	R559
63	QSP	QSP	R560
64	QSP	QSP	R561
65	QSP	QSP	R562
66	QSP	QSP	R563
67	QSP	QSP	R564
68	QSP	QSP	R565
69	QSP	QSP	R566
70	QSP	QSP	R567
71	QSP	QSP	R568
72	QSP	QSP	R569
73	QSP	QSP	R570
74	QSP	QSP	R571
75	QSP	QSP	R572
76	QSP	QSP	R573
77	QSP	QSP	R574
78	QSP	QSP	R575
79	QSP	QSP	R576
80	QSP	QSP	R577
81	QSP	QSP	R578
82	QSP	QSP	R579
83	QSP	QSP	R580
84	QSP	QSP	R581
85	QSP	QSP	R582
86	QSP	QSP	R583
87	QSP	QSP	R584
88	QSP	QSP	R585
89	QSP	QSP	R586
90	QSP	QSP	R587
91	QSP	QSP	R588
92	QSP	QSP	R589
93	QSP	QSP	R590
94	QSP	QSP	R591
95	QSP	QSP	R592
96	QSP	QSP	R593
97	QSP	QSP	R594
98	QSP	QSP	R595
99	QSP	QSP	R596
100	QSP	QSP	R597

EMC Add part 104pGND TO GND Only



PCB LAYOUT - TOP VIEW

C0202	A2	C214	C1	C261	C2	C342	B3	C4012	C4	C4072	A3	C442	B4	C490	C4	C716	A1	C818	D1	C912	C2	CN208	D2	FB210	D2	FB802	D1	IC402	C4	L403	A4	L704	A1	Q804	D1	R224	C2	R258	C2	R289	D2	R312	A2	R335	C3	R402	D4	R431	C4	R470	C4	R553	C3	R803	D1	R835	D2	XL401	D4
C0208	D2	C215	B1	C301	A2	C343	B2	C4013	C3	C4073	D2	C443	C4	C491	C4	C717	A1	C819	D1	C918	B3	CN301	B1	FB211	D2	FB803	D1	IC403	C4	L404	B4	L707	A2	Q805	D1	R225	B1	R259	C2	R290	D2	R313	B3	R336	C3	R4035	D3	R432	C4	R471	C4	R558	C3	R804	C2	R836	C1	ZD209	C2
C0211	D2	C216	C2	C302	A2	C345	A2	C4014	B4	C4075	D4	C444	A4	C492	C4	C718	A1	C820	D1	C919	B3	CN401	A3	FB212	D2	FB901	C1	IC404	C3	L405	B4	L801	C1	Q901	C1	R227	D2	R260	D2	R291	D2	R314	A2	R343	B2	R404	D3	R433	C4	R472	C3	R560	C3	R805	C2	R838	D1	ZD301	B3
C0235	C2	C217	B1	C303	A2	C346	B3	C4015	B4	C4076	D4	C453	C4	C493	C4	C719	A1	C821	C1	C920	C2	CN701A	B1	FB213	D2	FB905	D3	IC407	D3	L406	B4	L802	D1	Q903	D3	R228	D2	R261	C2	R292	B1	R315	B2	R344	B3	R405	D3	R434	C4	R474	C3	R601	C2	R806	D1	R839	C1	ZD302	B2
C0245	C1	C218	B1	C304	A2	C348	A2	C4018	B4	C4078	D3	C454	C4	C496	C4	C720	B1	C822	D1	C921	B1	CN702	A2	FB214	D2	FE312	A1	IC801	D1	L407	B4	L803	C1	R201	C2	R229	C2	R263	C2	R293	C2	R316	A2	R348	A2	R4051	A3	R435	C4	R475	C3	R603	A1	R807	D1	R840	D1	ZD901	D3
C0247	B1	C219	C2	C316	B2	C349	C2	C402	D4	C4080	D4	C455	C4	C497	A3	C721	A1	C823	C1	C922	C1	CN801	D1	FB217	B1	IC201	B1	JK301	A2	L408	B3	Q204	D2	R202	C2	R230	B2	R267	D2	R294	B1	R317	B2	R349	A2	R4052	D2	R436	C4	R476	C3	R604	A2	R808	D1	R841	C1	ZD904	C1
C0251	A2	C220	C2	C317	A1	C350	C3	C4020	A3	C4081	C4	C456	C4	C515	C3	C722	A1	C824	C1	C928	D2	CN802	D2	FB220	D2	IC202	C2	JK302	A1	L409	B3	Q205	D2	R203	C2	R231	B1	R268	C3	R296	D2	R318	A2	R352	B3	R4056	D2	R437	C4	R477	C3	R605	A2	R812	D1	R842	D1		
C0252	A2	C221	B1	C320	C3	C351	B3	C4029	C3	C410	D4	C457	C4	C516	D3	C723	A1	C825	C1	C929	B3	CN803	D2	FB222	D2	IC203	B2	JK401	A3	L410	B3	Q300	C2	R205	B1	R232	B1	R269	A2	R297	D2	R319	A2	R353	B3	R406	D3	R438	C4	R478	C4	R702	A1	R813	D1	R845	D2		
C101	C1	C229	B1	C321	B2	C352	A2	C403	D4	C412	D4	C460	D4	C517	C3	C730	A1	C827	C1	C932	D3	D201	D2	FB226	D1	IC204	B2	JK601	A1	L411	B3	Q305	A1	R207	D2	R233	B2	R270	C2	R298	D2	R320	A2	R354	A2	R407	D3	R439	C4	R479	C4	R704	A1	R814	D1	R904	D3		
C102	C1	C230	B2	C322	C3	C353	B3	C4030	C3	C423	D4	C461	A3	C601	A1	C732	B1	C829	C1	C935	C2	D202	D2	FB302	A1	IC205	D2	JK701	A1	L412	B3	Q405	D3	R208	C2	R234	B2	R271	C2	R301	A2	R321	B2	R355	A2	R408	D3	R440	C4	R480	C4	R705	A1	R815	D1	R913	C1		
C105	B1	C231	B2	C325	B2	C354	A2	C4031	C3	C424	D4	C470	C4	C602	A1	C736	A2	C830	C1	CE345	A2	D204	D2	FB310	B2	IC206	B2	JK702	A4	L413	A4	Q507	A2	R209	C2	R235	C1	R272	C2	R3018	B1	R322	B2	R358	B3	R412	D4	R449	D4	R481	C4	R724	A1	R816	D1	R924	C1		
C107	B1	C232	B1	C326	A2	C355	B3	C4032	C3	C427	D3	C471	C4	C702	A1	C737	A2	C831	C1	CE348	A2	D205	C2	FB312	B3	IC207	C2	JK704	A2	L414	A4	Q508	A2	R210	C2	R236	C1	R274	C1	R302	A2	R323	B2	R359	B3	R413	D4	R450	C4	R482	C4	R731	A1	R817	C1	R928	B3		
C201	C1	C237	C1	C327	A2	C360	C3	C4035	C3	C429	D3	C472	C4	C703	A1	C801	D1	C832	C1	CE351	A2	D600	C2	FB313	B3	IC208	C2	L201	B1	L415	A3	Q602	A1	R211	A2	R242	C2	R276	C2	R3021	A2	R324	B2	R360	B2	R414	D4	R452	C4	R483	C4	R732	A1	R820	D1	R929	B3		
C202	B1	C238	B1	C328	B2	C362	C2	C4036	A3	C431	C4	C473	C4	C704	A4	C803	C1	C833	C1	CE901	C1	F201	C2	FB401	D4	IC209	B1	L202	D1	L416	A4	Q611	A2	R212	A2	R245	B1	R277	C2	R3022	A2	R325	B2	R361	B3	R415	D4	R453	C4	R492	C3	R733	B1	R822	C1	RA201	B1		
C203	C1	C239	B1	C329	B2	C363	B3	C404	D4	C432	C4	C474	C4	C705	A4	C806	C1	C834	D2	CE903	B2	FB201	C2	FB603	A2	IC210	D2	L203	C1	L417	A3	Q705	A4	R213	C2	R248	D2	R278	C2	R303	A2	R326	B2	R368	B3	R416	D4	R454	C4	R493	C3	R734	A1	R823	D1	RA202	A2		
C204	D3	C242	C1	C330	B2	C4006	C4	C4045	C3	C433	D4	C475	C4	C706	A4	C809	C1	C838	C1	CE904	A2	FB202	B1	FB703	A1	IC301	A2	L204	A2	L418	A3	Q706	A1	R215	D2	R249	D2	R279	B1	R304	A2	R327	B2	R369	B3	R417	D4	R455	C4	R529	D3	R737	A2	R824	D1	RB401	D4		
C205	C2	C243	B2	C331	B2	C4007	C3	C405	D4	C434	C4	C476	C4	C707	A4	C810	D1	C839	C1	CN201	C2	FB203	B1	FB704	A4	IC302	B2	L205	B1	L501	C1	Q707	A1	R218	D2	R250	B1	R280	B1	R305	B1	R328	B2	R385	A2	R419	D4	R456	C4	R530	C3	R738	C2	R826	D1	RB402	D2		
C207	C2	C253	B1	C332	B2	C4008	C3	C406	D4	C435	C4	C477	C4	C708	A4	C811	D1	C840	C1	CN202	D2	FB205	C2	FB705	A4	IC304	B2	L206	C1	L502	C1	Q708	A1	R219	D2	R251	C2	R281	B2	R307	C3	R329	B2	R386	A2	R423	D4	R457	C4	R531	C3	R748	A1	R827	D1	RB701	A4		
C208	B1	C254	C2	C333	B2	C4009	C4	C4068	D3	C436	C4	C478	C4	C709	A4	C812	D1	C841	C1	CN203	B2	FB206	B2	FB706	A4	IC305	B2	L207	B1	L503	C2	Q724	A2	R220	A2	R252	C2	R285	D2	R308	A1	R330	B2	R387	A2	R424	D4	R458	C4	R532	D3	R751	A1	R829	C1	RB901	D3		
C210	C2	C255	B1	C334	B3	C401	D4	C4069	A3	C437	C4	C481	B3	C710	A1	C813	C1	C843	C1	CN204	D2	FB207	B2	FB708	C2	IC306	B2	L302	A2	L701	A1	Q801	C1	R221	A2	R253	B1	R286	B2	R309	A2	R331	B2	R389	B2	R425	D4	R459	C4	R533	D3	R752	A1	R831	D2	XL201	B1		
C211	A2	C257	D2	C340	B2	C4010	C4	C407	D4	C438	C4	C482	C4	C711	A1	C816	C1	C844	C1	CN205	D2	FB208	B2	FB715	B1	IC309	B1	L401	A4	L702	A1	Q802	D1	R222	B2	R254	A2	R287	B2	R310	A2	R332	B3	R390	D2	R426	D4	R460	C4	R546	A2	R801	D1	R833	C1	XL202	D2		
C213	B1	C260	D2	C341	B3	C4011	C4	C4071	A3	C439	C4	C483	B4	C713	A1	C817	C1	C849	C1	CN206	D3	FB209	D2	FB801	D1	IC401	D4	L402	B4	L703	A1	Q803	C1	R223	C2	R257	D2	R288	D2	R311	A2	R334	B2	R401	D4	R429	C4	R461	C4	R552	C3	R802	D1	R834	C1	XL203	B1		

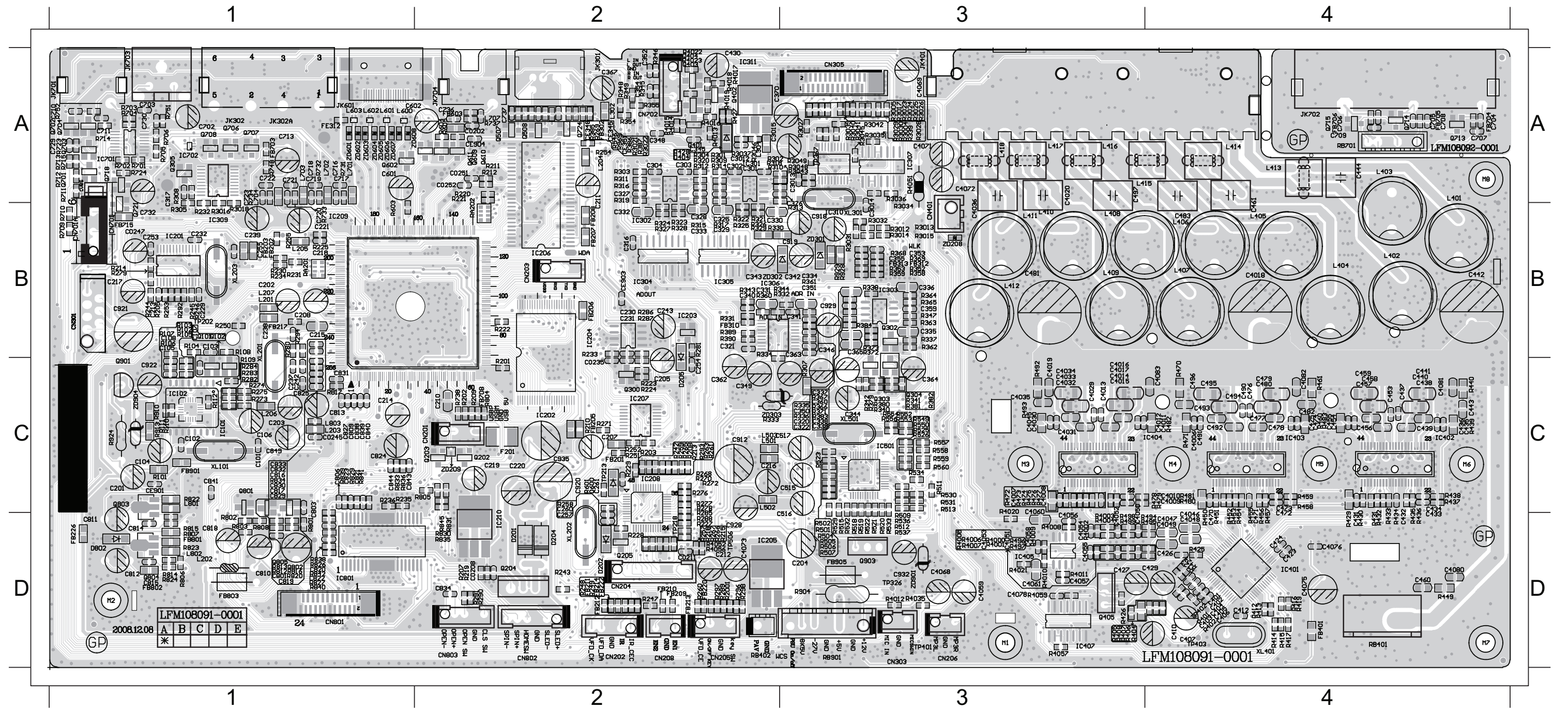



# PCB LAYOUT - BOTTOM VIEW

C0201 C4 C0218 B3 C0241 A1 C206 B4 C308 A3 C4002 A2 C4039 B2 C409 D1 C446 B1 C469 B1 C511 C2 C802 D4 C904 D2 CE215 A4 CE309 D2 CE323 B3 CE804 D3 D414 A2 FE309 B4 R217 B4 R388 B4 R4036 A1 R4050 A2 R443 B1 R484 A2 ZD401 D1  
 C0203 B4 C0219 B3 C0242 B3 C209 B4 C309 B3 C4003 A2 C4040 B2 C411 D1 C447 B1 C484 B1 C512 C2 C804 C4 C905 B4 CE216 B4 CE310 A3 CE324 B3 CE805 D3 D415 D3 FE310 A4 R238 B3 R399 B3 R4037 A2 R4053 D2 R444 B1 R485 A2 ZD902 D2  
 C0204 B4 C0220 B3 C0243 B3 C223 C3 C311 B3 C4004 B1 C4041 A2 C413 D1 C448 B1 C485 B1 C513 C2 C805 D4 C906 C4 CE217 B4 CE311 C2 CE325 B3 CE806 D3 FB204 B4 FE311 A3 R239 C3 R4024 A1 R4038 A1 R4054 D3 R445 A1 R486 B2  
 C0205 D4 C0221 B3 C0244 B4 C224 D3 C313 B3 C4005 B2 C4042 A2 C414 D1 C449 A1 C486 A1 C514 C2 C807 D4 C907 D2 CE218 B4 CE312 C4 CE326 D2 CE807 D3 FB216 C3 IC406 A1 R256 D3 R4025 A1 R4039 A1 R4061 A1 R446 A1 R487 B2  
 C0206 B4 C0222 B3 C0246 B4 C225 B4 C315 B3 C4021 B2 C4043 B2 C415 D1 C450 A1 C487 A2 C528 D1 C808 C4 C908 C3 CE219 B4 CE313 D2 CE327 D4 CE808 D3 FB223 D2 Q206 D3 R264 D3 R4026 A1 R4040 A1 R4062 A2 R447 B1 R488 A2  
 C0207 C3 C0226 C3 C0248 B4 C226 B4 C318 B2 C4022 B2 C4044 B2 C416 D1 C451 B1 C488 B1 C589 B1 C826 C4 C924 D2 CE220 B4 CE314 C3 CE328 A4 CE809 D3 FB601 A3 Q207 B4 R299 D3 R4027 A2 R4041 A1 R409 D1 R448 B1 R489 A2  
 C0209 B4 C0227 C3 C0249 B4 C227 B4 C319 B2 C4023 B2 C4062 A1 C417 D1 C452 B1 C489 B1 C590 B1 C828 C4 CE201 D3 CE301 D4 CE315 B2 CE329 B4 D406 A1 FB602 B4 Q407 A2 R3019 B3 R4028 A2 R4042 A2 R410 D1 R462 A1 R490 B2  
 C0210 B4 C0228 B3 C0253 B4 C228 B4 C323 B4 C4024 B2 C4063 A1 C419 D1 C462 B1 C498 B1 C600 B4 C835 D4 CE202 D3 CE302 C4 CE316 A3 CE330 C4 D407 A1 FB707 B4 Q408 A2 R3020 B3 R4029 A2 R4043 A2 R411 D1 R463 A2 R491 B2  
 C0212 C3 C0229 B3 C0601 B4 C233 D3 C324 B3 C4025 A2 C4064 A2 C420 D1 C463 B1 C499 B2 C603 A3 C836 B4 CE203 D3 CE303 C4 CE317 A3 CE346 A3 D408 A2 FB712 A4 Q409 A2 R350 A4 R403 D1 R4044 A2 R418 D1 R464 B1 R606 B4  
 C0213 C3 C0230 B3 C0602 A3 C243 C3 C356 A4 C4026 A2 C4065 A2 C421 D1 C464 B1 C506 C2 C701 A4 C837 B4 CE204 D3 CE304 D4 CE318 C1 CE347 A3 D409 A2 FE301 B4 Q410 A2 R351 A4 R4030 A1 R4045 A2 R420 D1 R465 B1 R750 B4  
 C0214 B3 C0237 B3 C0603 A3 C256 D3 C357 A4 C4027 B2 C4066 A2 C422 D1 C465 B1 C507 C2 C728 B4 C846 C4 CE205 D3 CE305 A4 CE319 C2 CE352 B3 D410 A2 FE302 B4 Q411 D3 R356 A4 R4031 A1 R4046 A2 R421 C1 R466 A2 R754 A4  
 C0215 C3 C0238 B3 C0604 B4 C305 A3 C366 A3 C4028 B2 C4067 A2 C425 D1 C466 A1 C508 D2 C731 A4 C901 D2 CE206 D3 CE306 D3 CE320 C2 CE801 D3 D411 A2 FE306 A3 Q601 A3 R357 A4 R4032 A2 R4047 A2 R422 C1 R467 A2 R911 D2  
 C0216 B3 C0239 B3 C0606 B4 C306 A3 C4000 B1 C4037 B2 C4070 A1 C428 D2 C467 A1 C509 C2 C735 B3 C902 D2 CE207 D3 CE307 C4 CE321 B3 CE802 D3 D412 A2 FE307 B4 R204 C3 R375 C3 R4033 A2 R4048 A2 R441 A1 R468 B1 RA203 B4  
 C0217 B4 C0240 B3 C109 C4 C307 A3 C4001 B2 C4038 B2 C408 D1 C445 B1 C468 B1 C510 C2 C738 B4 C903 D2 CE212 D3 CE308 C2 CE322 B3 CE803 D3 D413 A2 FE308 A4 R216 B4 R378 B4 R4034 A2 R4049 A2 R442 A1 R469 B2 ZD309 C3

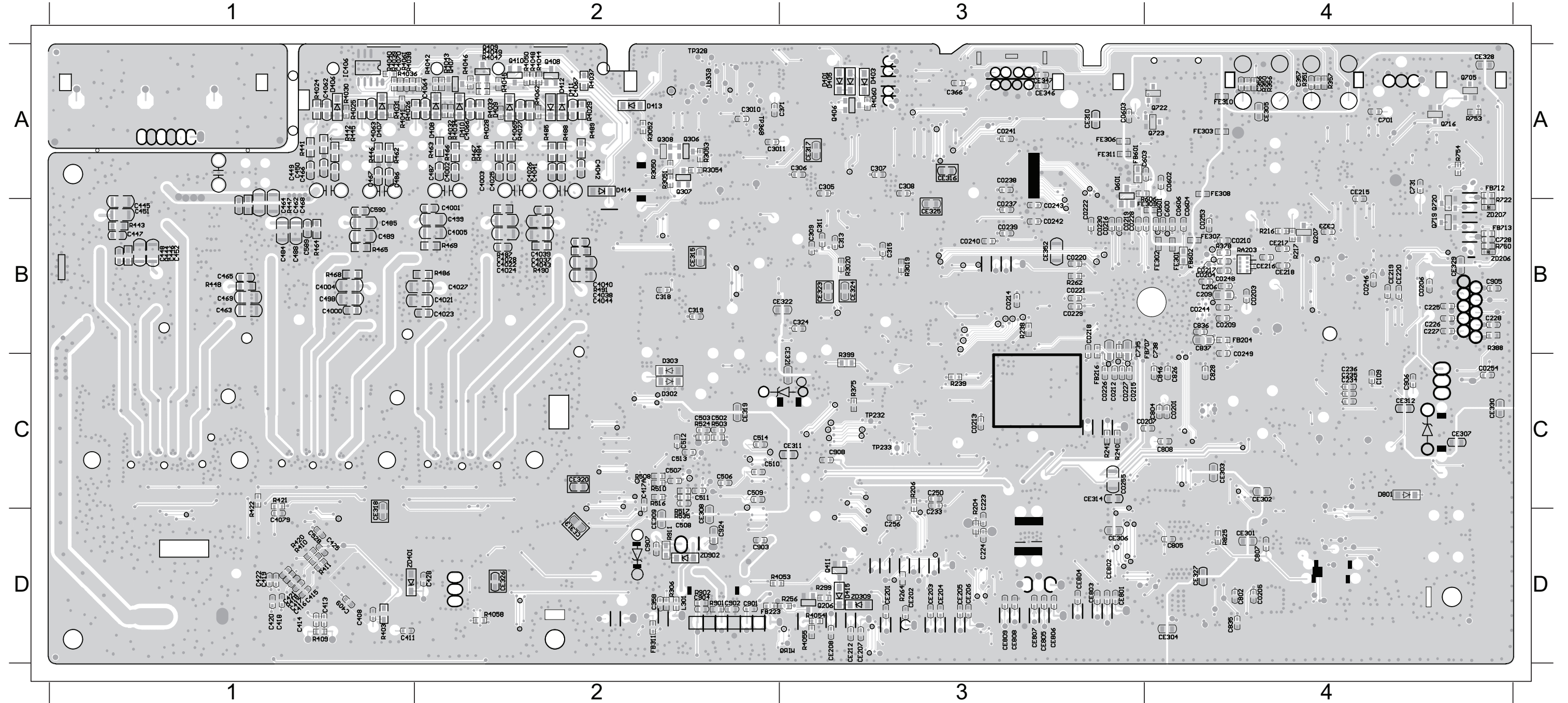

---

---

# POWER BOARD

---

---

TABLE OF CONTENTS

Internal IC Diagram .....	7-1
Circuit Diagram .....	7-2
PCB Layout Top View .....	7-3
PCB Layout Bottom View .....	7-4

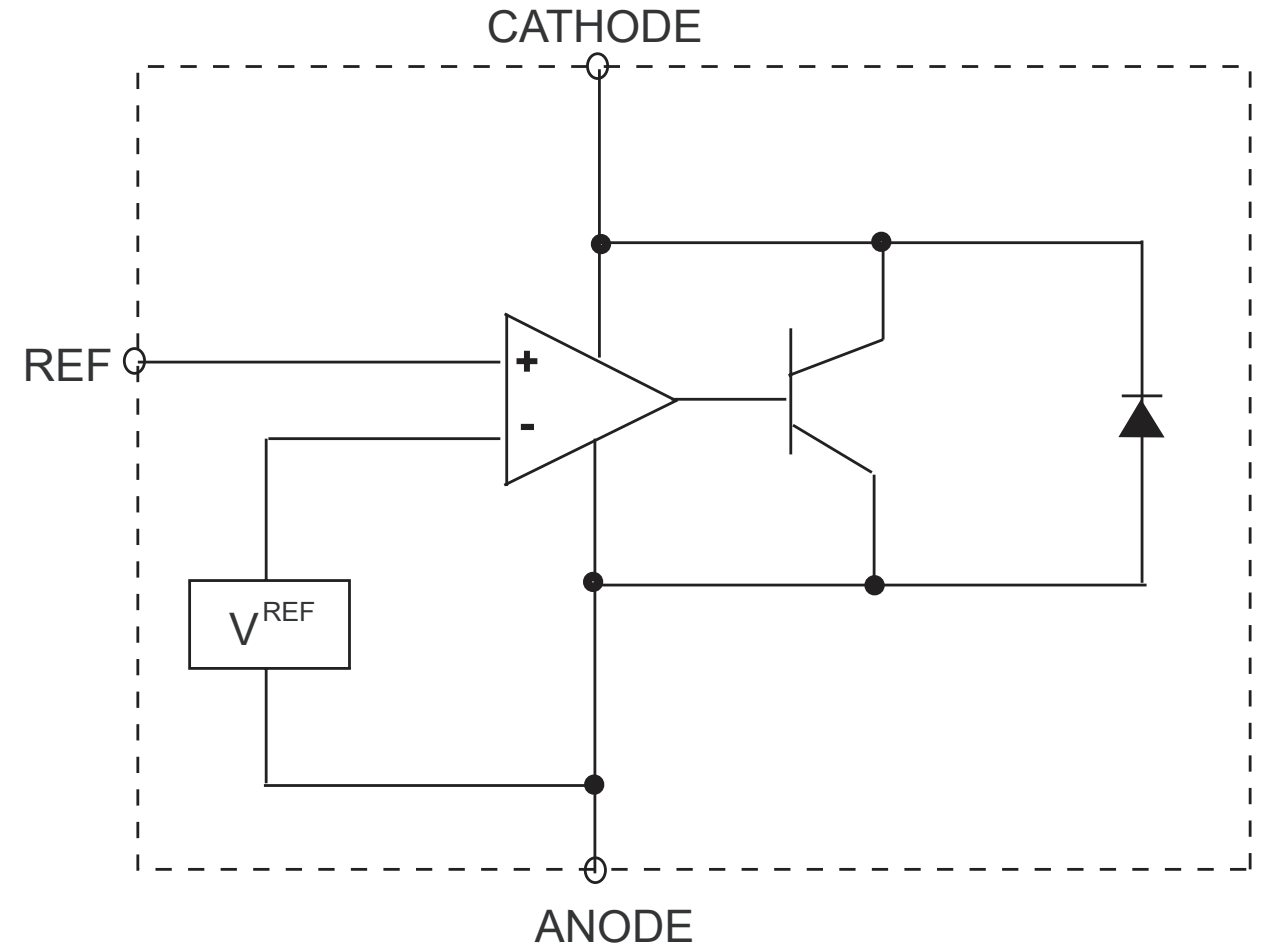

# CIRCUIT DIAGRAM

BD901A1 C910 D3 C923 D2 C936 B2 C947 C3 C957 A4 C965 C3 C974 B4 C985 B3 D904 B4 D914 A4 D924 A3 IC905 B4 L908 A3 Q911 B3 R904 C1 R914 C1 R924 A3 R933 C2 R941 A3 R950 A2 R964 B3 R972 B4 R982 A4 T903 A2 ZD906D4  
 C901 D1 C915 C1 C924 D2 C938 C3 C948 C3 C958 A4 C966 B3 C975 C4 CN901D1 D905 B3 D915 C2 D927 C4 J901 A1 NTC901C1 Q912 B2 R905 C1 R915 A1 R925 C3 R934 C2 R942 B2 R951 A2 R965 B3 R973 A3 R983 C2 TVR901C1 ZD907B4  
 C902 D1 C916 C2 C925 D3 C941 C2 C949 A3 C959 C3 C967 B3 C978 C2 CN903D4 D906 A2 D916 A3 D928 C4 L901 C1 Q903 C3 Q913 A2 R906 C3 R916 A1 R926 C3 R935 B3 R943 B2 R954 D3 R966 B3 R975 A4 R985 D2 TVR902A1 ZD908A4  
 C903 D1 C917 B1 C927 C3 C942 C2 C950 A2 C960 C3 C968 A3 C980 C4 CN904C4 D907 B3 D917 C2 F901 C1 L902 B1 Q904 C4 Q914 B3 R907 C3 R917 A1 R927 C3 R936 B3 R944 A2 R956 C3 R967 B3 R976 A4 R986 B4 TVR903A1 ZD909A4  
 C904 A1 C918 B1 C928 C3 C943 B2 C951 A3 C961 C3 C969 A3 C981 C4 CN905A4 D908 B3 D918 C2 GT902C1 L904 C3 Q905 D4 Q918 C3 R908 C3 R918 A1 R928 D2 R937 D3 R945 A3 R957 C4 R968 B3 R977 A3 R987 D3 ZD902C2 ZD910A4  
 C905 A1 C919 B1 C929 C3 C944 A2 C952 A2 C962 C3 C971 A3 C982 B3 CN906B4 D909 B2 D919 C3 IC901C2 L905 C3 Q906 C3 R901 D4 R909 A3 R919 C4 R929 D2 R938 C3 R946 D4 R960 A4 R969 B4 R978 C3 R989 B3 ZD903B2 ZD913A3  
 C906 D1 C920 A1 C930 B4 C945 A2 C955 C3 C963 C3 C972 A3 C983 B3 D902 A4 D910 B4 D922 C3 IC902D2 L906 C3 Q907 C4 R902 C1 R911 C4 R920 C3 R931 B2 R939 C3 R948 D3 R961 C4 R970 A4 R979 C4 T901 C2 ZD904A2  
 C907 C4 C921 A1 C934 C2 C946 A2 C956 C3 C964 C4 C973 C3 C984 B3 D903 B3 D912 A4 D923 C3 IC904D3 L907 A3 Q910 B3 R903 C1 R912 B1 R922 D3 R932 C4 R940 C1 R949 A2 R963 B3 R971 A4 R980 C4 T902 B2 ZD905A3

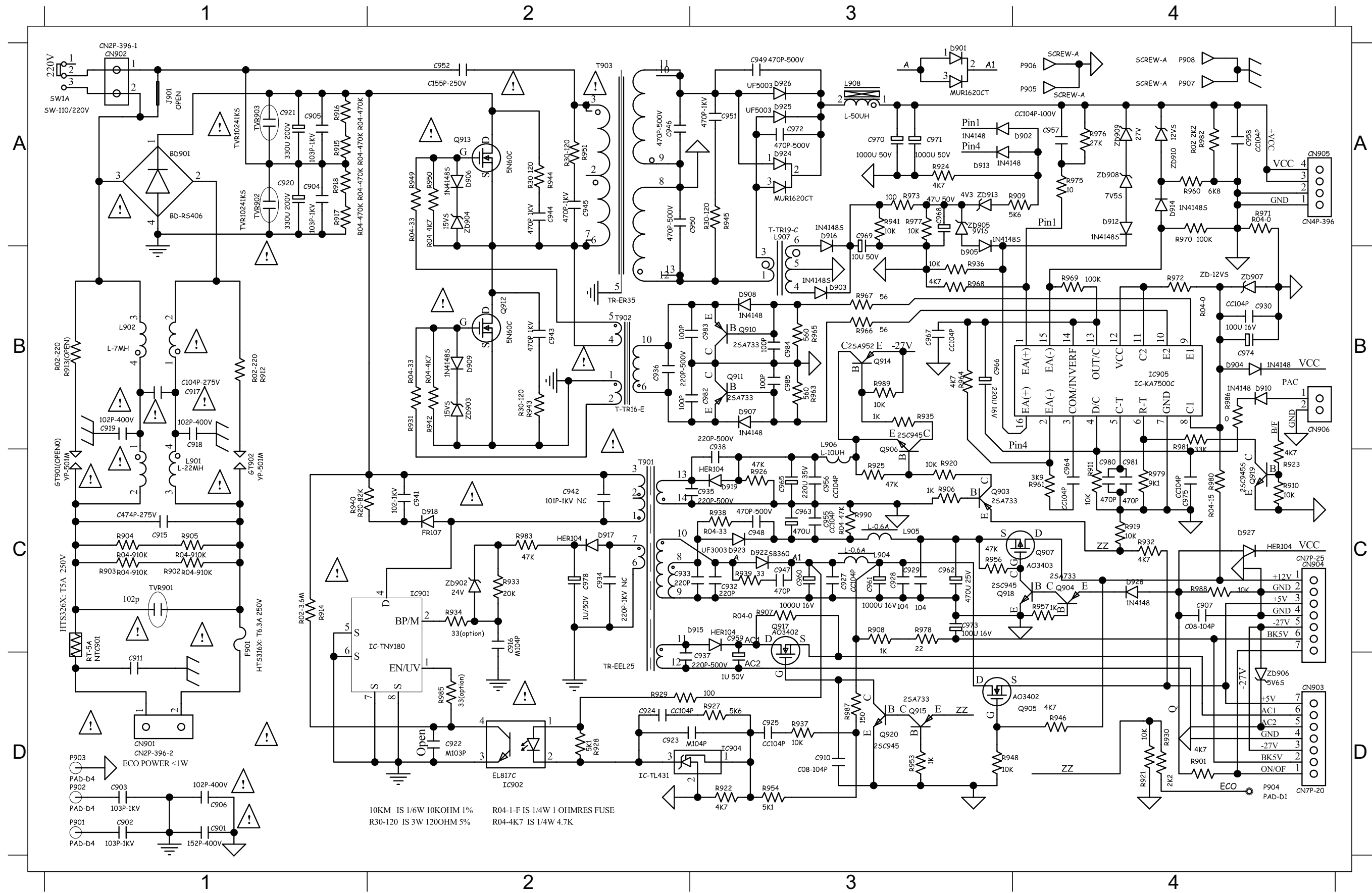

10KM IS 1/6W 10KOHM 1% R04-1-F IS 1/4W 1 OHMRES FUSE  
 R30-120 IS 3W 120OHM 5% R04-4K7 IS 1/4W 4.7K



# PCB LAYOUT - TOP VIEW

BD901B1	C906	A3	C920	A2	C959	A3	C966	B4	C975	C4	CN906C4	D917	B2	D927	B4	IC905	B4	J906	C2	J912	A4	J919	A4	J925	C4	L901	D4	L908	C4	Q914	A3	R940	B2	R949	C2	R975	C4	T902	B3	ZD904C2	
C901	C3	C915	D1	C921	A1	C960	B4	C968	C3	C978	B2	D907	B3	D918	A1	F901	D2	J901	A1	J907	C2	J913	A4	J920	A4	J926	C4	L902	B1	NTC901D1	R901	A4	R943	B2	R951	D2	R978	A4	T903	C2	ZD913C4
C902	D2	C916	A2	C923	A3	C961	B4	C969	C3	CN901D1	D908	B3	D919	A3	GT902C1	J902	C1	J908	C2	J914	A4	J921	B4	J927	B4	L904	A4	Q910	B3	R912	C1	R944	C2	R960	C4	R980	B4	TVR901D1			
C903	B2	C917	C1	C941	A2	C962	B4	C971	D4	CN903A4	D909	B2	D922	B3	IC901	A2	J903	B1	J909	D2	J915	A4	J922	B4	J928	C4	L905	B4	Q911	B3	R914	A2	R945	D3	R966	B3	R982	D4	TVR902A1		
C904	A1	C918	C1	C945	D2	C963	B4	C973	A4	CN904B4	D910	C4	D923	B3	IC902	A3	J904	A2	J910	A3	J917	A4	J923	B4	J929	C4	L906	A3	Q912	B2	R929	A3	R946	A4	R967	B3	R983	B2	TVR903B1		
C905	B2	C919	C1	C952	B2	C965	A3	C974	B4	CN905D4	D915	B4	D924	D4	IC904	A3	J905	A3	J911	A4	J918	A4	J924	C3	J930	C4	L907	C3	Q913	C2	R931	C2	R948	B4	R968	C4	T901	A1	ZD903B2		

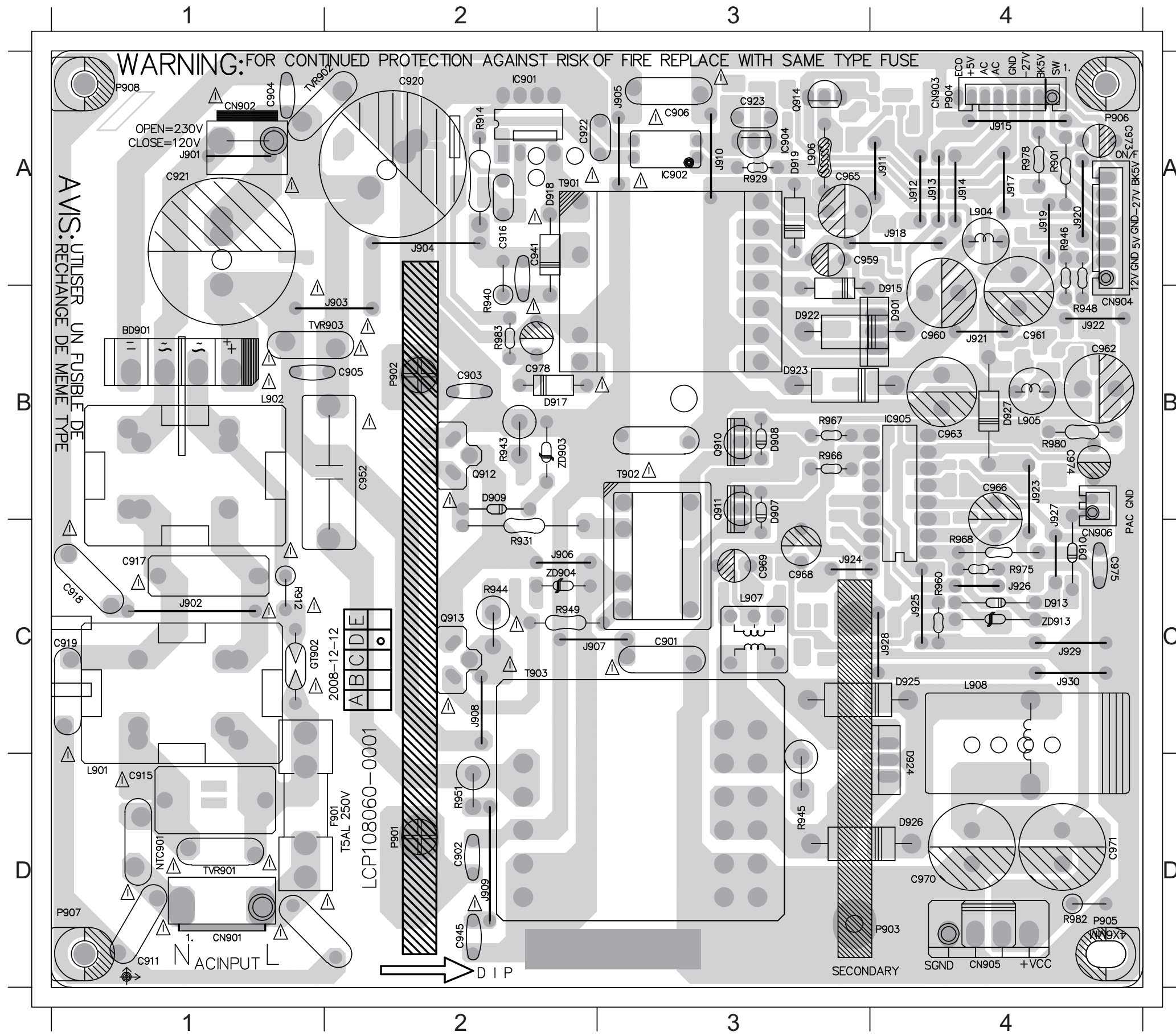

# PCB LAYOUT - BOTTOM VIEW

7 - 4

7 - 4

C907 B1 C928 A1 C938 A2 C947 B2 C955 B1 C967 B2 C983 B2 D904 B1 D916 C2 Q906 A2 R904 D4 R909 C1 R918 A3 R925 A2 R933 A3 R938 B2 R954 A2 R964 B1 R972 B1 R985 A3 ZD905 C2 ZD910 C1  
 C910 A2 C929 B1 C942 A3 C948 B2 C956 A2 C972 C2 C984 B2 D905 C2 D928 B1 Q907 B1 R905 D4 R911 B1 R919 A1 R926 A2 R934 A3 R939 B2 R956 B1 R965 B2 R973 C2 R986 C1 ZD906 A1  
 C924 A2 C930 B1 C943 B3 C949 D2 C957 C1 C980 B1 C985 B2 D906 C3 Q903 A1 Q918 B1 R906 A1 R915 A3 R920 A1 R927 A2 R935 A1 R941 C2 R957 B1 R969 B2 R976 C1 R987 A1 ZD907 B1  
 C925 A2 C934 B2 C944 C3 C950 C2 C958 D1 C981 B1 D902 C1 D912 C2 Q904 B1 R902 D4 R907 A2 R916 A4 R922 A2 R928 A2 R936 C2 R942 B3 R961 C1 R970 B2 R977 C2 R989 A1 ZD908 C2  
 C927 B1 C936 C2 C946 D2 C951 D2 C964 B1 C982 C2 D903 C2 D914 C1 Q905 A1 R903 D4 R908 A1 R917 A3 R924 C1 R932 A1 R937 A2 R950 C3 R963 B2 R971 B1 R979 B1 ZD902 A3 ZD909 C2

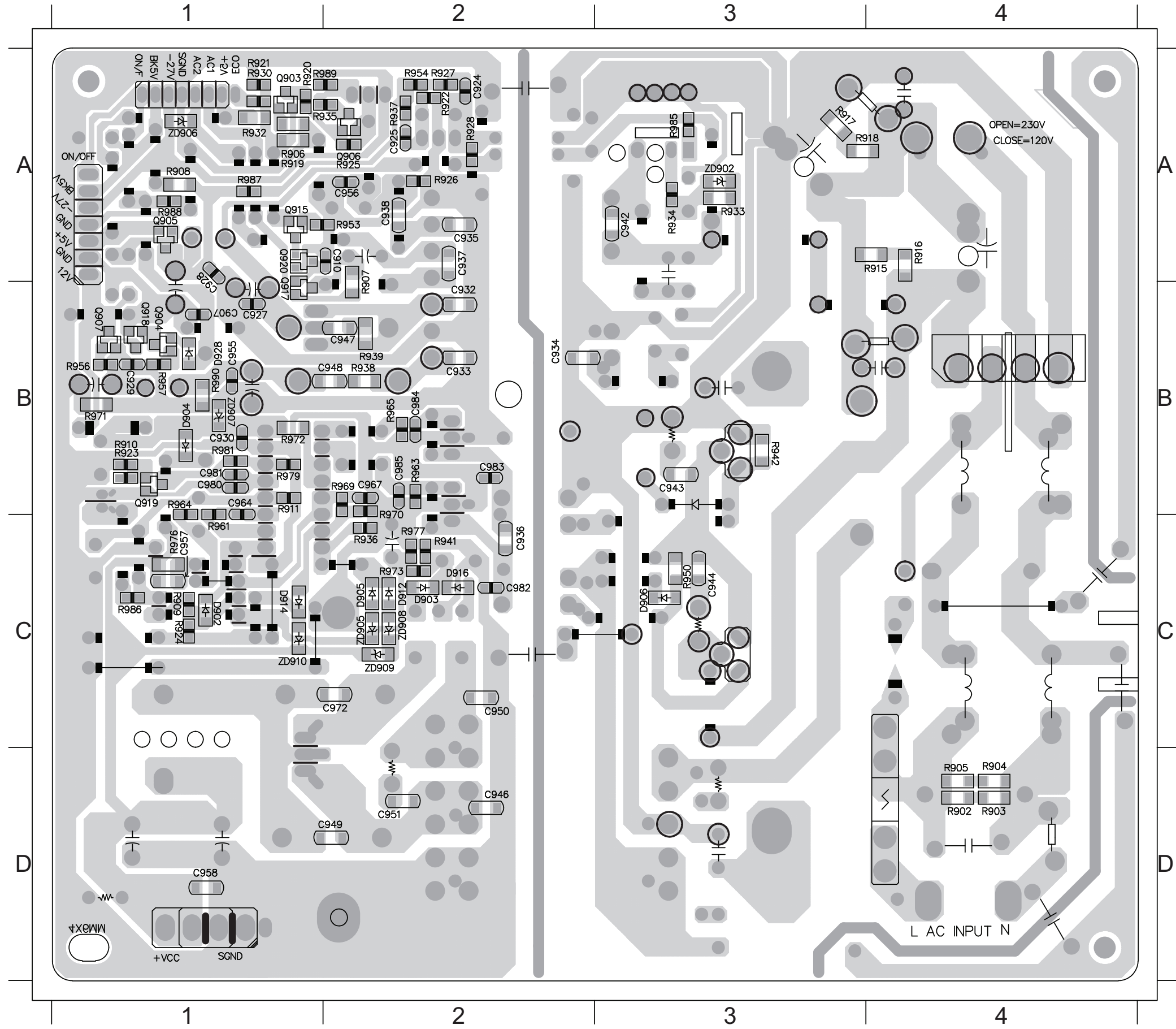



---

# MP3 IN BOARD

---

TABLE OF CONTENTS

Circuit Diagram.....8-1  
PCB Layout Top & Bottom View.....8-2

# CIRCUIT DIAGRAM

C383 A3 FB351 A1 FB352 A1 FB355 A3 FB356 A3 FB357 A3 JK351 A2 R3079 A1 R3080 A1 RB352 A1 RB354 A2 USB351 A3

1

2

3

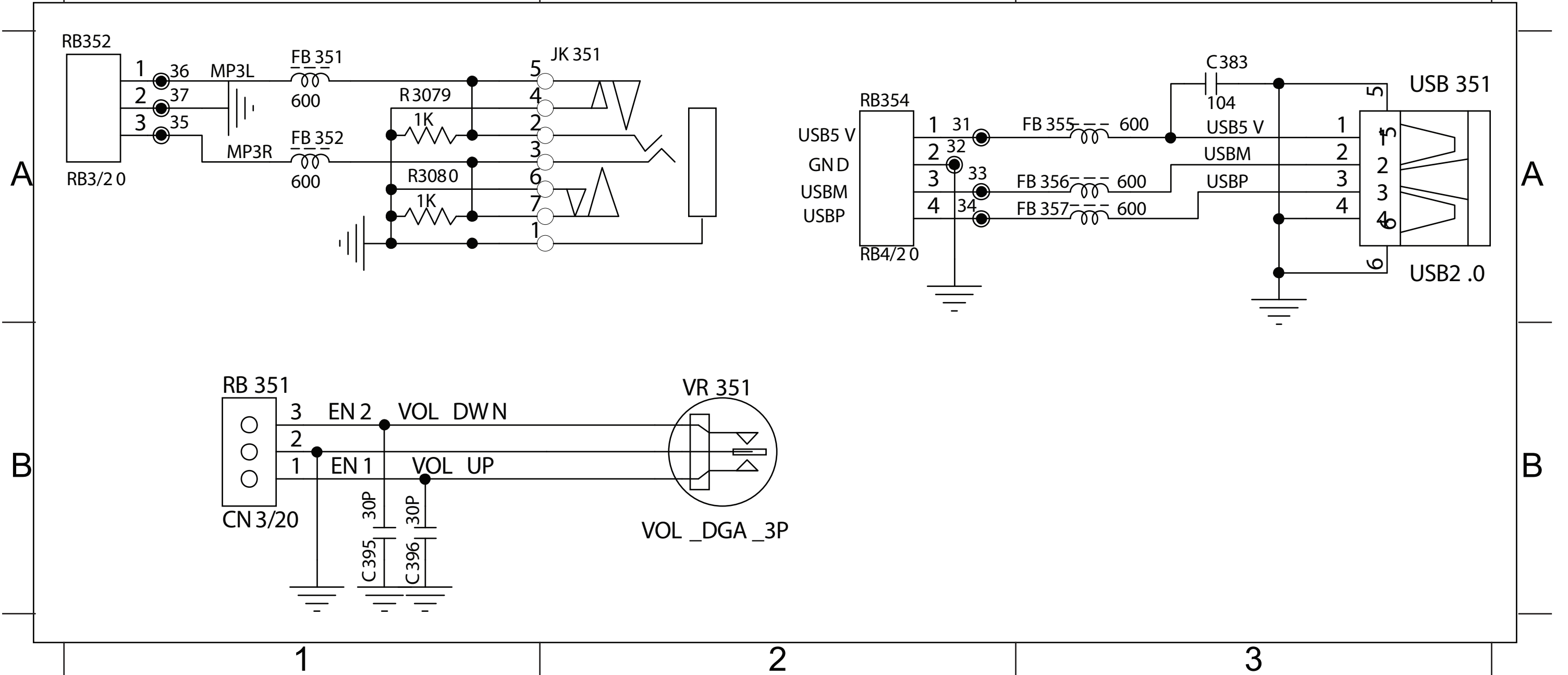

# PCB LAYOUT - TOP VIEW

8-3

J360 A2 J361 A1 JK351 B1 RB352 A1 RB354 A1 USB351 A2

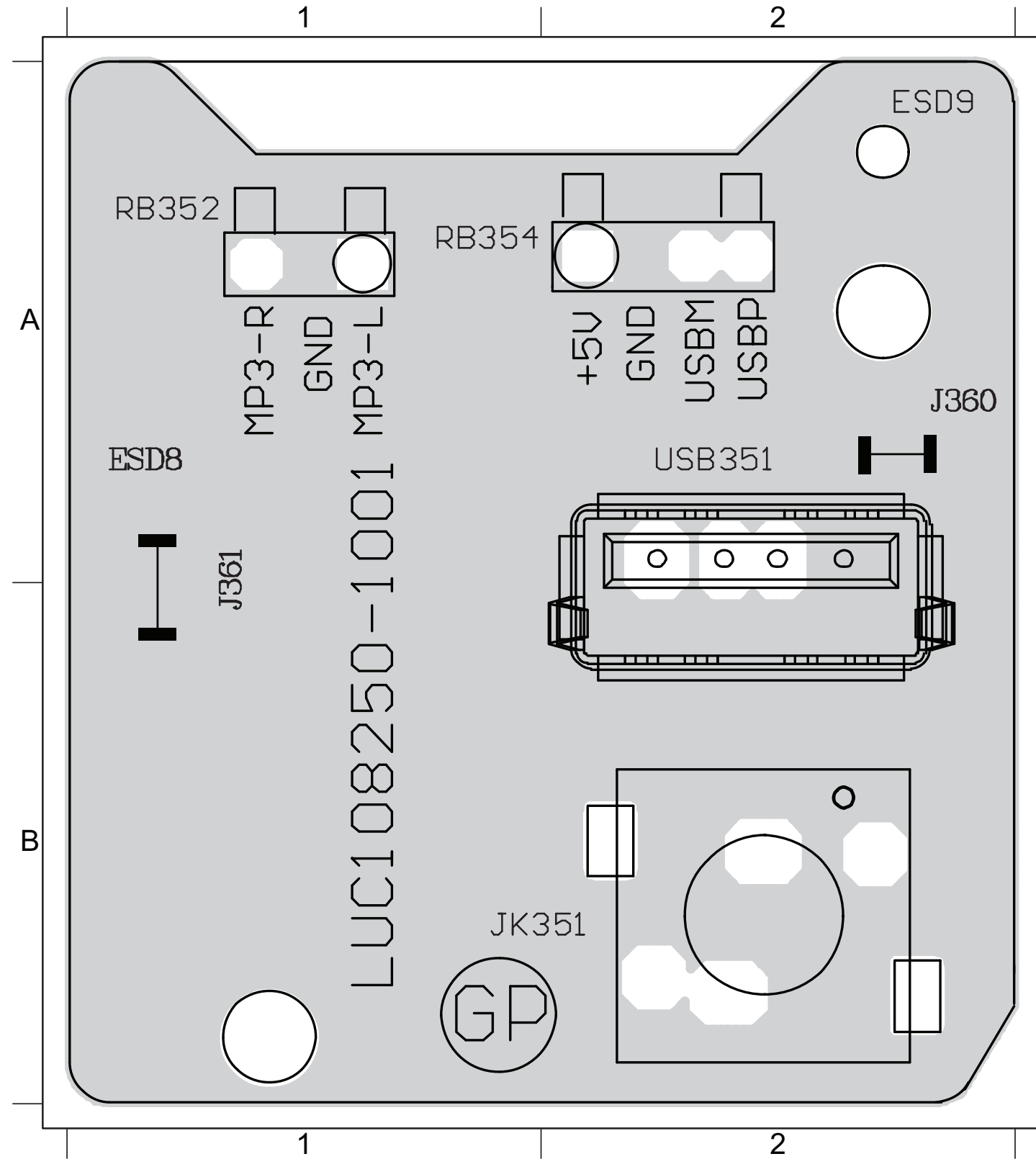

# PCB LAYOUT - BOTTOM VIEW

8-3

C383 A2 FB351 A2 FB352 A2 FB355 A2 FB356 A1 FB357 A1 R3079 A2 R3080 A2

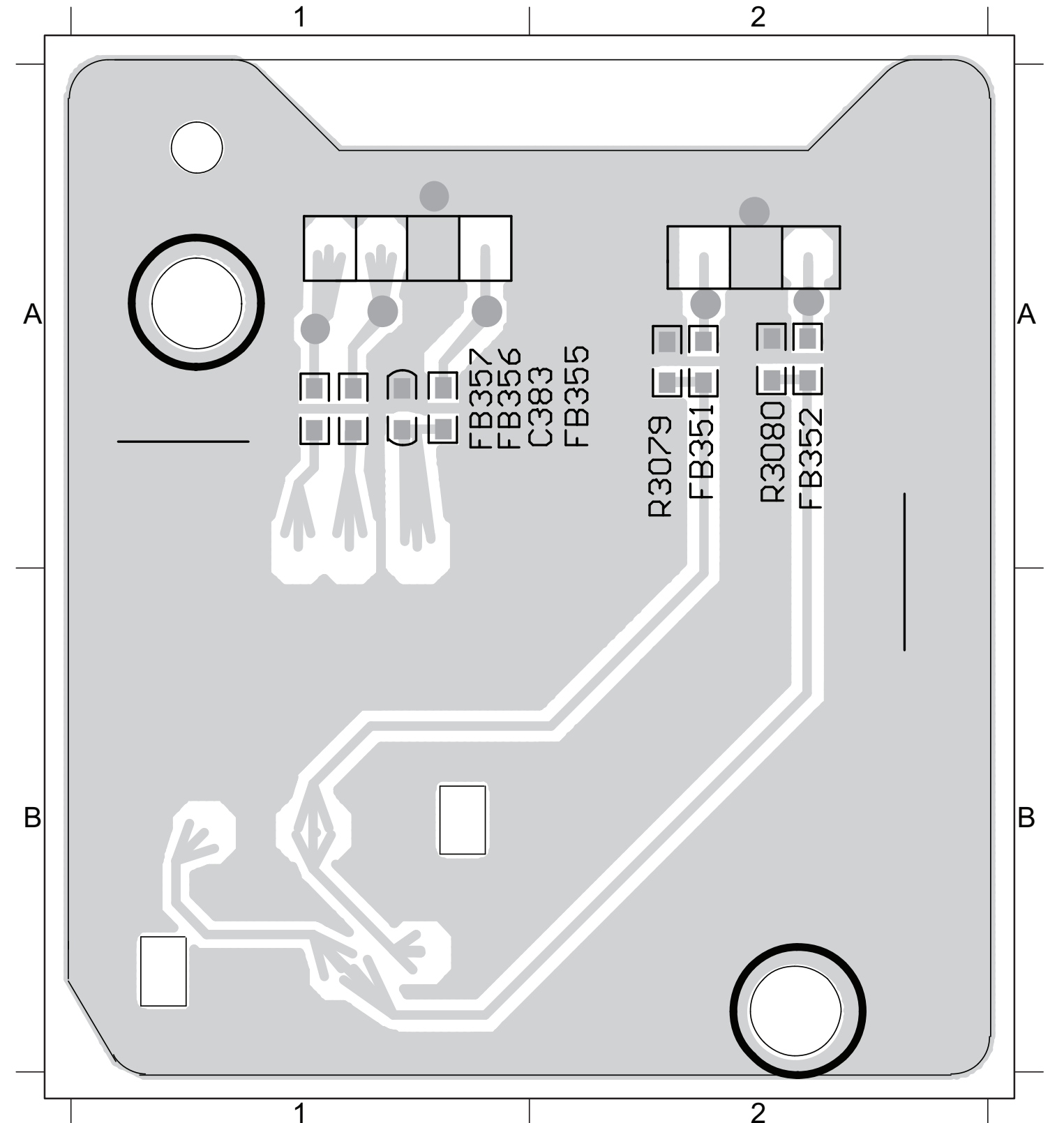

Mechanical Exploded View

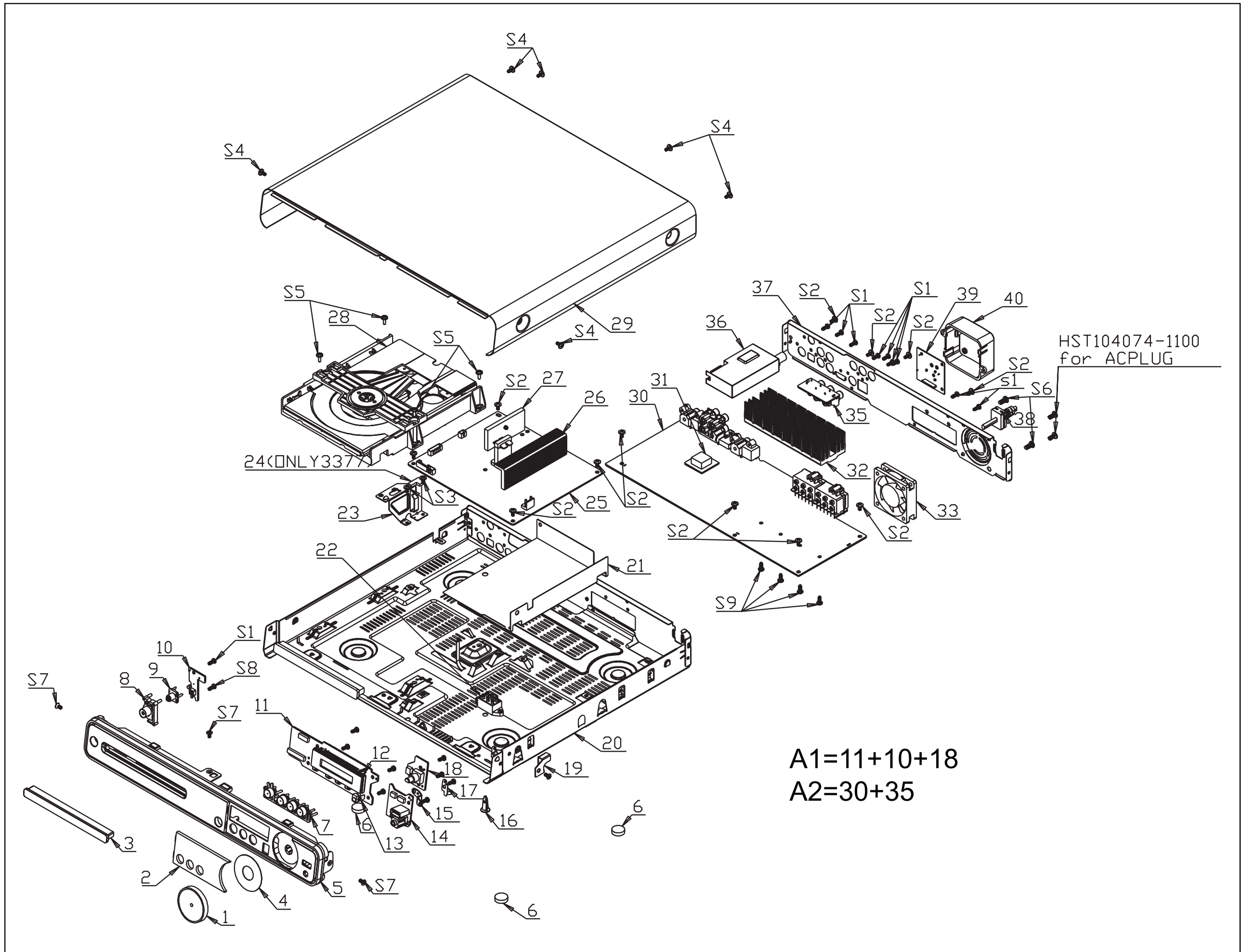

**MECHANICAL & ACCESSORIES PARTS LIST**

Loc.	12NC	Description
<b>MAIN UNIT</b>		
1	996510021087	VOLUME KNOB
2	996510021093	DISPLAY LENS
3	996510021117	DVD DOOR ABS
5	996510021139	FRONT PANEL
7	996510021068	FUNCTION KNOB
8	996510021069	STANDBY KNOB
9	996510021064	STANDBY LENS
14	996510021066	MP3 IN PCB ASSY
28	996510021248	DVD LOADER
33	996510021076	FAN DC12V 0.55A
36	996510017572	TUNER PACK KST-MT001FS0-6BK
38	△ 996510001252	POWER CORD
FM	996510008251	FM ANT
IPOK	996510021131	SIMPLE IPOD DOCK MODULE
JK351	996510004129	KARAOKE JACK D3.6MM 7P
RC	996510021121	REMOTE CONTROL 39 KEYS
V1	996510007429	FFC CABLE 10P100mm UL20798 P1
VIDEO	996500013058	RCA CABLE 2P 1.2M
25	996510021128	POWER PCB ASS'Y
A1	996510021089	DISP+LED+VOL PCB ASSY
A2	996510021119	MAIN+YUV PCB ASS'Y

**LOUDSPEAKER SYSTEM**

SPKC	996510021124	SPEAKER BOX-CENTER
SPKFL	996510021123	SPEAKER BOX-FRONT LEFT
SPKFR	996510021125	SPEAKER BOX-FRONT RIGHT
SPKRL	996510021126	SPEAKER BOX-REAR LEFT
SPKRR	996510021127	SPEAKER BOX-REAR RIGHT
SUBW	996510021118	SUBWOOFER

**ELECTRICAL PARTS LIST**

Loc.	12NC	Description
<b>DISP+LED+VOL PCB ASSY</b>		
IC351	996500029614	IC 52P PT6311(PTC)
LD351	996510020167	LED 3 DIA ULTRA RED TINT CLEAR
Q351	994000000921	XISTR PNP 2SA812 HFE:200-400
Q352	994000000915	XISTR NPN 2SC1623
SN351	994000005472	IRT RECEIVER IRM-2638AF4

**ELECTRICAL PARTS LIST**

Loc.	12NC	Description
<b>POWER PCB ASS'Y</b>		
BD901	996510011372	BRIDGE KBU808 8A 800V
C901	996500027115	CAP.SAFETY Y1 102PF 250V 20% Y5
C902	996500018042	COND DISC 0.01UF 1KV 20%
C906	994000005344	CAP.SAFETY Y1 560PF 400V 10%
C915	996510012548	GOND SAFETY 0.47uF 275V 10% X2
C917	994000005343	COND SAFETY 0.22UF 275V 20%
C920	996510012472	COND ELEC 330uF 200V 20%
C941	996510021078	COND DISC 1000 pF 1KV 10%
C945	996500020264	COND DISC 470PF 1KV 10%
C952	996510018266	COND METAL 1.5uF 250V DC 10%
CN901	996510018268	CONNECTOR 4P P=3.96mm180' NICK
CN903	996500015901	CONNECTOR 6P P=2.0MM
CN904	996510021055	CONNECTOR B7B-XH-A 7P
CN905	996510016729	CONNEC 4P P=3.96mm 180' NICKEL
CN906	996500015898	CONNECTOR 2P PITCH=2.0MM
D907	996500026949	DIODE SW 1N4148 PB<1000PPM
D915	996510012516	DIODEHER105 DO-411A400V50nSFMS
D918	994000001571	DIODE FR107 1A 1000V
D922	994000005249	DIODE SB360 3A 60V DO-201AD
D923	994000000943	DIODE UF3003 3A 200V
D924	994000005346	RECTIFIER UF1602CT TO-220AB 3P
F901	△ 996500042572	FUSE 5A 250V SLOW
IC901	996510021079	IC 8P(P3=N.C) TNY180PN DIP-8C
IC902	994000000946	OPTICAL SENSOR 4P
IC904	994000000952	IC 3PIN TL431
IC905	996510008293	IC 16P AZ7500BP-E1
L901	996510021083	COMMON COIL 6mH 21.5Ts D0.6mm
L902	996510021053	COMMON COIL 15mH 37.5Ts D0.6mm
L904	996500016694	6UH 13.5TS 2UEW
L907	996500027102	TOROID COIL S1=1TS D0.65MMX2 P
L908	996510012474	COMMON COIL75uH10%1KHz/0.25VD1
Q903	994000000921	XISTR PNP 2SA812 HFE:200-400
Q905	996510008289	FET AO3402 SOT23 30V/4A
Q906	996510004282	XISTR NPN SMT (2SC945)
Q907	996510018395	FET AO3401 SOT23 -30V/-4.2A
Q910	996500026946	XISTR PNP 2SB772P/Q NEC PB<10
Q912	996510021085	MOSFET STK1060F TO220F AUK600V
Q914	996510010356	XISTR PNP 2SB647 TO-92MOD
R943	996510012519	RES. 120 OHM 3W 5% MOF
T901	△ 996510021071	TRASFO EEL25 7+7P 40W 100KHz
T902	△ 996510021088	TRASFO EEL19 5+5P 100KHz 20W
T903	△ 996510021086	TRASFO ERL35 7+7P 150W 100KHz
ZD903	994000002067	DIODE ZENR 14.5-15.1V 0.5W

**Note:** Only these parts mentioned in the list are normal service parts.

**ELECTRICAL PARTS LIST**

Loc.	12NC	Description
<b>MAIN+YUV PCB ASS'Y</b>		
CN201	996500015859	CONNECTOR 4PIN P2.0MM
CN202	996510012494	CONNECTOR 5P RED
CN204	996500017367	CONNECTOR 8P
CN205	996510012495	CONNECTOR 4P
CN206	996500015897	CONNECTOR 3P RED P2.0MM
CN301	996510012497	FPC/FFC CONN. 10P
CN401	996500015862	CONNECTOR B2B-XH-A 2P
CN701A	996500015901	CONNECTOR 6P P=2.0MM
CN702	996500015895	CONNECTOR 5P P=2.0MM
D201	996510010358	DIODE 1N4007
IC201	996510012499	IC 28P
IC202	996510021129	IC 48P KH29LV320DBTC-70G
IC203	994000005209	IC 3P AZ809NSTR-E1 SOT23
IC204	996510004289	IC 8P TU24C16CS2 SOIC TURBO
IC205	996510021062	IC 3P LD1117ADJ SOT223 3.3VST1A
IC206	996510016601	IC 54P HY57V641620F(L/S)TP-6
IC207	996510012500	IC 20P SN74HC244PWR TSSOPTI
IC208	996510021132	IC 48P STM32F101C6A LQFP ST
IC209	996510021133	IC 256P MT1389DXE/SN LQFP
IC210	996500027090	IC 3P AP1117E18LA 1.8V SOT2
IC301	996510020341	IC 8P D4558 SOP SILICORE
IC304	996510012503	IC 16P CD4051BM SOIC TI ANALOG
IC306	996510021056	IC 20P WM8781GEDS SSOP WOLFSON
IC401	996510021092	IC 64P TAS5508APAG TQFP TI
IC402	996510021081	IC 44P TAS5352ADDV HTSSOP TI
IC407	996500023948	IC 14P 74HCU04D PHILIPS TSOP
IC801	996510010380	MOTOR DRIVE IC
JK301	994000005447	DIN JACK 8P BLK
JK302	996510021122	JACK 4P WHT-RED/WHT-RED
JK401	996510013837	SPK JAC12P RD-WT-GRN-GRY-BLU
JK601	996510012507	HDMI JACK 19P PDVBT8-19 FLBS4N
JK701	996510012481	RCA JACK 1P YELLOW W/GND
JK702	996500012609	RCA JACK R/G/B
JK703	996510015645	TOSL JACK PLR131/T2 RECEIVER
JK704	996500017363	RCA JACK 1P W/GND P
L401	996510021061	INDUCTOR 10uH 20% 10A
Q204	996510012508	XISTR PNP TIP42C
Q205	996510000578	XISTR NPN KTC3875-Y
Q206	994000000915	XISTR NPN 2SC1623
Q405	996500028742	XISTR NPN 2SD882P PB<1000PPM
Q408	994000000921	XISTR PNP 2SA812 HFE:200-400
Q601	996510008289	FET AO3402 SOT23 30V/4A
Q602	996500041281	FET 2N7002 60V/115MA
Q801	996510004117	FET 2SK3018 30V/0.1A SC-70
Q803	996500026927	XISTR PNP 2SB1132RT100 ROHM HF
Q901	996510000615	XISTR NPN 2SC945P
Q903	996500026946	XISTR PNP 2SB772P/Q NEC PB<10
XL401	996510021091	CRYST 13.5MHz HC-49US 20ppm20pF
ZD901	994000005204	DIODE ZENR 12.6-13.1V 0.5W
ZD904	996500028741	DIODE ZENR 9.1-9.5V 0.5W PB<10

# REVISION LIST

10 - 1

10 - 1

Version 1.0  
\*Initial release